

S A M M Y ' S

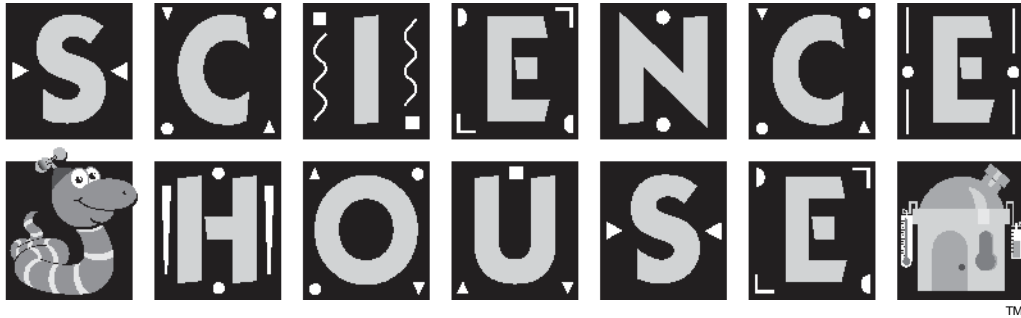

Teacher's Guide

Province of BC Licensing Agreement



www.hmco.com

© 1999-2006 Riverdeep Interactive Learning Limited, and its licensors. All rights reserved. This product contains Macromedia Flash™ Player software by Macromedia, Inc., © 1995-2004 Macromedia, Inc. All rights reserved by their respective parties. Edmark, Bailey's Book House, Millie's Math House, Sammy's Science House, Trudy's Time and Place House (as applicable to specific product), Learning Management System, Riverdeep, and the Riverdeep logo are trademarks or registered trademarks of Riverdeep Interactive Learning Limited. Adobe and Reader are either registered trademarks or trademarks of Adobe Systems Incorporated in the United States and/or other countries. Macintosh and Mac are registered trademarks of Apple Computer, Inc. Macromedia and Flash are trademarks of Macromedia, Inc. Microsoft, Windows and the Windows logo are registered trademarks of Microsoft Corporation in the United States and/or other countries. All other trademarks are the property of their respective owners.

USE OF THIS PRODUCT IS SUBJECT TO CERTAIN RESTRICTIONS AND LIMITATIONS OF WARRANTY UNDER THE LICENSE AGREEMENT CONTAINED HEREIN.

Riverdeep grants limited permission to classroom teachers to duplicate the reproducible portions of this publication for classroom use only and for no other purpose. In the interest of product improvement, information and specifications represented herein are subject to change without notice.

Introduction



Third in Edmark's award-winning *House Series*, *Sammy's Science House* joins *Millie's Math House* and *Bailey's Book House* in bringing your students a world of learning and hours of fun. With its colorful characters, animated pictures, friendly voices and engaging music, *Sammy's Science House* nurtures children's curiosity and encourages a sense of wonder and joy in discovering the world of science around them.

Sammy's Science House provides seven engaging activities that help children practice sorting, sequencing, observing, predicting, and constructing. Children learn simple scientific classification and discover how plants and animals live and respond in a pond environment. They build toys and machines to print

and read and print a "Field Notebook" of interesting information about animals.

Five activities have a Discover Mode and a Question and Answer Mode so that children use divergent and convergent thinking. Make-A-Movie has Question and Answer Mode only, and Recycle It! has Discover Mode only. These experiences help children practice both their creative thinking skills and their logical reasoning skills while gaining confidence in their knowledge and skills.

The *Curriculum Connections* section in this Guide provides dozens of interdisciplinary activities for use in the classroom and at home. Reproducible activity sheets and illustrations are included to provide additional learning opportunities before and after using the software.

Powerful technology and proven educational methods have been combined in *Sammy's Science House* to ensure success for a wide variety of students, including all young students. Spoken instructions allow pre-readers and readers alike to work independently. Using the computer as a tool, students gain a sense of accomplishment and skill as they create, play, and learn.

Table of Contents

What's in This Guide?	2		
Steps to Start	3		
What's Inside Sammy's Science House	4		
Learning Opportunities Matrix	5		
Assessment Option	7		
Moving Around the House	8		
Introducing Sammy to Your Students	9		
Sammy's Map	10		
Sammy's Icons	11		
Activity by Activity			
in Sammy's Science House			
Workshop			
Overview.....	13		
Discover Mode	14		
Question and Answer Mode.....	15		
Together Time.....	16		
Weather Machine			
Overview.....	17		
Discover Mode	18		
Question and Answer Mode.....	19		
Together Time.....	20		
Sorting Station			
Overview.....	21		
Discover Mode	22		
Question and Answer Mode.....	23		
Together Time.....	24		
Make-A-Movie			
Overview.....	25		
Question and Answer Mode.....	26		
Together Time.....	28		
Acorn Pond			
Overview.....	29		
Discover Mode	30		
Question and Answer Mode.....	32		
Together Time.....	33		
		Create-A-Critter	
		Overview.....	34
		Discover Mode.....	35
		Question and Answer Mode.....	36
		Together Time.....	37
		Recycle It!	
		Overview.....	38
		Discover Mode.....	39
		Together Time.....	40
		Curriculum Connections	41
		Characters for Bulletin Boards, Computers,	
		and Chalkboards.....	42
		Workshop.....	45
		Weather Machine.....	52
		Sorting Station	61
		Make-A-Movie	66
		Acorn Pond.....	74
		Create-A-Critter.....	80
		Recycle It!	83
		System Requirements	89

What's in This Guide?

Introductory information (pages 2–12)

- *Steps to Start* information
- Visual overview of the program
- Activity descriptions
- Learning opportunities matrix
- Assessment option
- Program navigation for teachers and students
- Suggestions for introducing *Sammy's Science House* to your students
- Reproducible quick reference pages for your students

Activity by Activity in Sammy's Science House (pages 13–40)

Helpful information about each activity including:

- **Overview**, giving a summary of the activity, learning opportunities, and suggested extension activities for home and school. Learning Objectives show what is assessed. Learning Opportunities describe additional goals your students will meet using these activities.
- **Discover Mode**, explaining how your students can learn by experimenting in the activity.
- **Question and Answer Mode**, explaining how a character asks a question and is looking for a “right” answer. The character also offers gentle help and fun rewards.
- **Together Time Activities**, offering suggestions for easy, at-home activities which integrate learning into everyday situations.

Curriculum Connections (pages 41–88)

- Suggested activities, which can be integrated within many curricular areas. These activities strengthen the learning opportunities found in *Sammy's Science House*.
- Reproducible sheets (for student handouts, bulletin board headings, and overhead transparencies), which can be used in conjunction with *Curriculum Connections* activities.

System Requirements (page 89)

Steps to Start

1. Install Sammy's Science House.

- Please see "System Requirements" on page 89.

2. Read the Teacher's Guide.

- *What's Inside Sammy's Science House* (page 4) and *Moving Around the House* (page 8) will help you begin using *Sammy's Science House* immediately. *Curriculum Connections* (pages 41–88) offers additional suggestions and supplemental materials to help you integrate *Sammy's Science House* with classroom activities.

3. Become familiar with the program. ■ Try the software before you introduce *Sammy's Science House* to your students.

- Decide if you want to introduce the activities to your students one at a time, or let them explore at their own pace.

4. Introduce Sammy to your students.

- Reproduce (for each student) or make overhead transparencies of *Sammy's Map* and *Sammy's Icons* (pages 10 and 11).
- See *Introducing Sammy to Your Students* (page 9) for suggestions.

To play an activity in **Sammy's Science House**, click one of the areas below:

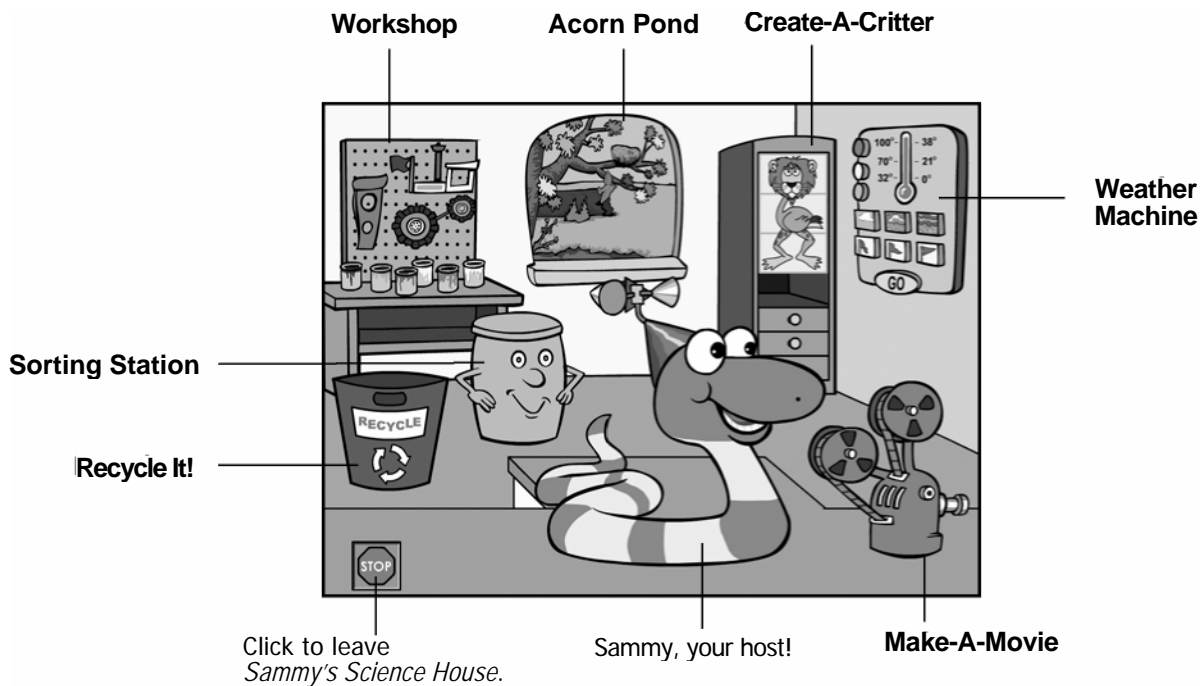

What's Inside Sammy's Science House

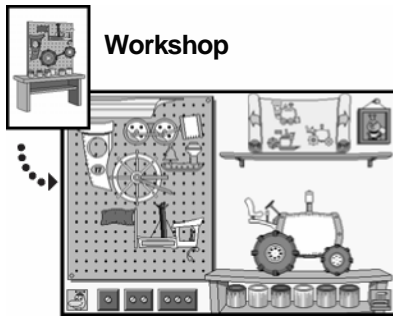

Construct toys and machines. Follow a blueprint or make your own design. Paint and print your creations.

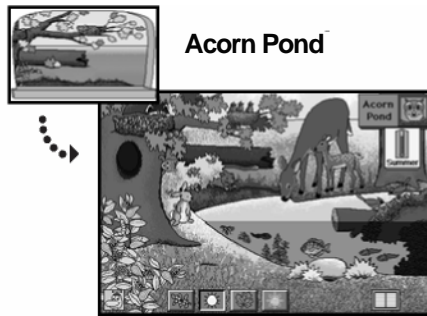

Investigate plants and animals as they adapt to seasonal change. Print a Field Notebook with interesting facts for future reference.

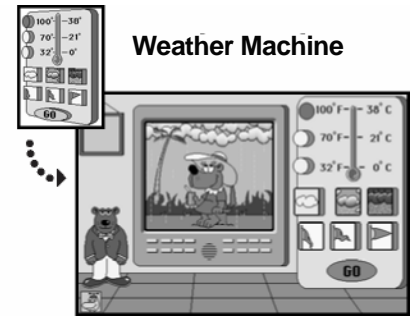

Manipulate weather variables. Listen to the weather report and watch animations illustrating the weather you've created.



Sort bottles, papers, cans, banana peels and more! Put trash into the correct bins to clean up each scene.

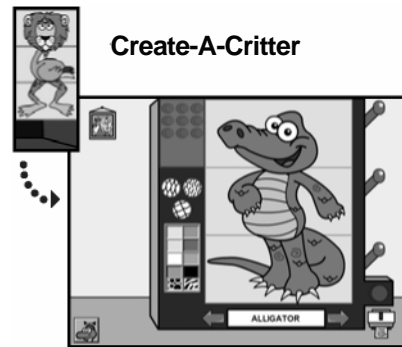

Learn about animals then make your own wacky animals with the Create-A-Critter Contraption.

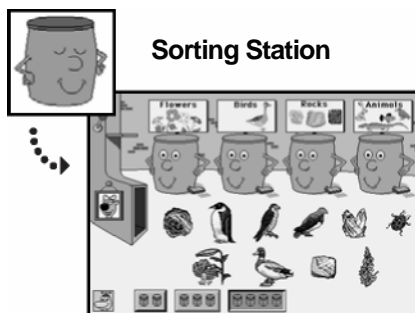

Sort pictures into categories with the help of friendly bins. Hear the names of plants, animals, and minerals.

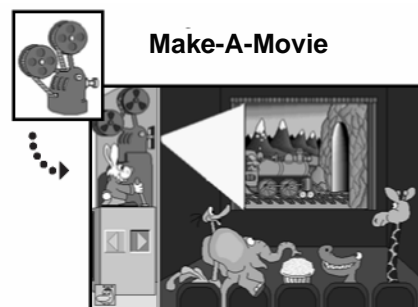

Arrange pictures in sequence to make a movie. Play your movie forward or backward.

Learning Opportunities Matrix

	Workshop	Weather Machine	Sorting Station	Make-A-Movie	Acorn Pond	Create-A-Critter	Recycle It!!
Discover that an object is made of parts smaller than the whole object	X			X			
Construct objects with and without a pattern	X						
Discriminate attributes	X		X		X	X	X
Form and test hypotheses	X	X	X	X	X	X	X
Manipulate variables that create weather conditions		X					
Notice that changes in key variables cause changes in weather conditions		X					
Hear and use scientific terms		X	X		X		
Group pictures by attribute or scientific classification			X		X	X	X
Identify similarities and differences among pictures	X		X	X			
Discover how plants and animals are often classified			X				
Apply logic to order pictures in a series				X			
Discover that some groups of pictures make sense in more than one order				X			
Examine a sequence forward and backward				X			
Explore how things in nature change over time				X	X		
Observe seasonal change		X			X		
Investigate animal habitats					X		
Recognize animals that have different types of body covering			X		X	X	
Know facts about animals and their habitats			X	X	X	X	
Identify and sort items for recycling and for compost							X

Notes...

Assessment Option

An assessment of student learning, designed specifically for young children, is available for each activity and may be used to test learning objectives, should the teacher choose to use it. The questions are presented verbally, and the choice of answers presented in picture form. Both are in an understandable format for young children who might well be non-readers.

Modification, Adaptation, or Alternative Approaches to Evaluation

Some educators may not choose to “test” their very young students in a formal manner, or they may have some students with specialized needs who cannot easily use the formal assessment as presented.

Some suggestions to consider follow:

- Introduce the test to the class by means of a projector and large screen encouraging group participation.
- Encourage students to click again on the question if they are not sure what is said.
- Provide an assistant, parent volunteer, or peer tutor to help a child having difficulties “getting started”.
- Check the lighting and minimize the glare on the computer monitor (pulling blinds or setting up a screen) if there seem to be visual concerns.
- Use individual ear phones and/or adjust amplification needs for students with attention or hearing concerns.
- Sign language interpretation for questions may be helpful to some children.

Moving Around the House

To move from the Main Room to an activity, click one of these:



Click Sammy **to return to the Main Room** from any activity in the Science House.



When students enter an activity, they will initially be in the Discover Mode. Emphasis is placed upon students experimenting freely by clicking objects and icons to see what happens. With students in charge, divergent thinking is encouraged by playful, positive responses to their natural curiosity. Click the framed picture (each activity has a different picture) **to enter the Question and Answer Mode**.

Note: Make-A-Movie and Recycle It! have one mode only.

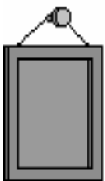

When students are in the Question and Answer Mode of an activity, a character will ask questions or make requests. Convergent thinking is emphasized as the character offers gentle feedback and guides students toward a “correct” answer. Click the empty picture frame **to return to the Discover Mode**.



Click the printer **to print** in the Workshop (page 14) and Acorn Pond (page 30).

Introducing Sammy to Your Students

- Turn on the computer and launch *Sammy's Science House*. Use a large screen monitor if one is available. Hand out copies of Sammy's Map and Sammy's Icons (pages 10 and 11).
- Point out the Main Room. Discuss the Stop Sign if students are allowed to exit.
- Ask a volunteer to click an activity icon. Explain that students will first see the Discover Mode. Point out the framed picture, explaining that when one of Sammy's friends is there, students can freely explore the room to discover what happens. (Indicate that Make-A-Movie and Recycle It! have one mode only.)
- Have another volunteer click the framed picture. Point out to students that the frame is now empty; a character will make a request because they are in the Question and Answer Mode. Explain that if they have trouble finding the answer, the character will help them.
- Help students understand that any time during play, they can:
 - go back to the Discover Mode by clicking the empty picture frame;
 - go back to the Main Room by clicking the Sammy icon.
- If printing is available, point out the printer icon in the Workshop and the Field Notebook of Acorn Pond.
- Have students begin using *Sammy's Science House*. You may want to use one of the activities in *Curriculum Connections* to introduce a computer activity. For example, "Sound Sorting" (page 61) is a helpful introduction to the Sorting Station computer activity.
- As students work in different activities of *Sammy's Science House*, copy and send home the corresponding *Together Time Activities* (pages 16, 20, 24, 28, 33, 37, and 40).
- Use selected activities found in *Curriculum Connections* as follow-up exercises (pages 41–88).

Sammy's Map

Click the activity you want to enter:

Workshop

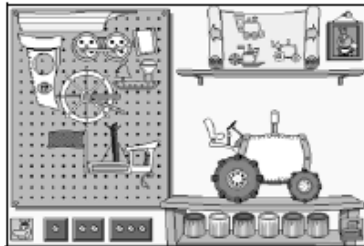

Acorn Pond



Create-A-Critter



Weather Machine



Recycle It!

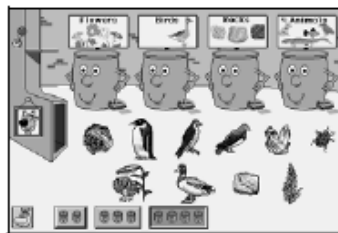

Sorting Station

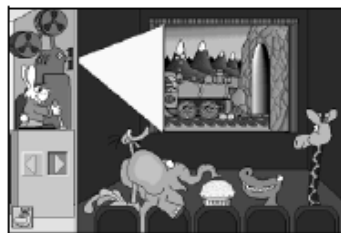

Make-A-Movie

Sammy's Icons

Click:



To go back to



To hear questions

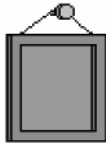

To explore



To print



To exit



Workshop Overview

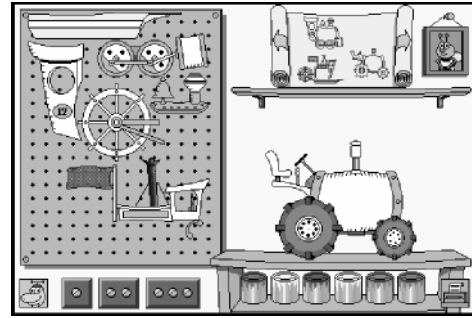
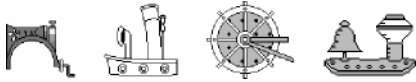

Let's build in the Workshop! Students construct imaginative toys and machines using blueprints and parts from a pegboard. With the same parts, students can also create their own designs. In the Discover Mode, they can paint and print their designs. In the Question and Answer Mode, fun-filled animations illustrate what they have built.

Learning Objectives

- Construct whole objects from smaller parts

Learning Opportunities

- Observe that parts of an object are smaller than the whole object
- Follow a pattern to construct an object
- Create unique objects from a set of parts
- Understand that some complete objects can perform functions the individual parts cannot
- Analyze, predict, and test which parts are needed to build a specified object

Together Time Activities (page 16)

(To copy and send home)

- Twin Towers
- Nature Names

Curriculum Connections (pages 45–51)

- It Moves! (Problem Solving)
- Living Alphabet (Language Arts)
- Kazoo Konzert (Music)
- Sunshine Time (Mathematics)
- All Around the Neighborhood (Social Studies)
- Buzzy Bee's Bucket Magnifier (Science)



Workshop Discover Mode





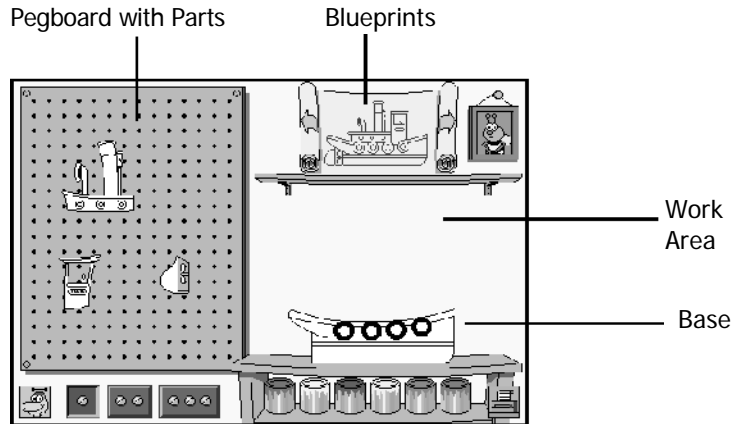

- Click  to enter the Workshop from the Main Room.



- The Workshop contains blueprints and a pegboard with parts. A "base," or main part, is shown in the work area. Build an object by adding parts to the base.





- Drag parts from the pegboard to the Work Area. Follow the blueprint or build whatever you like.

- Click , , or  to select blueprints for one, two, or three objects.

- Click  or  to see new blueprints and a new set of parts.

- To paint a part, click a paint pot . Then position the brush  inside the area you wish to paint. Click the mouse button to spread the paint. If you want to paint another part or change colors, click a paint pot and repeat the process.

- Click  to print a picture of what you built. Once printed, you may want to add drawings of people and scenery, etc.

- Click  for the Question and Answer Mode, or click  to return to Sammy's Main Room.



Workshop

Question and Answer Mode

- Click  to enter the Question and Answer Mode.

- Buzzy, the bee, asks you to make something. To hear the request again, click Buzzy.

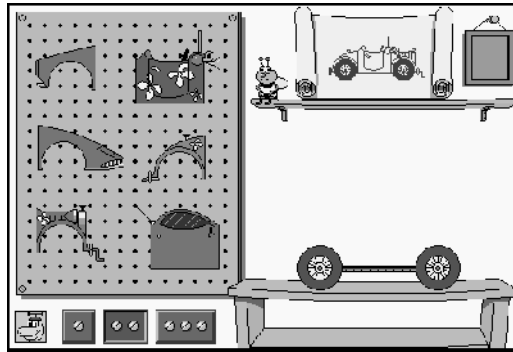

"Please build this car."

- You can select the blueprints and parts that you want to use. Click:



or



or



Build the object shown on blueprint using all parts

Build the object from a variety of parts. (Some parts may not be needed to finish blueprint.)

Build the object from a variety of parts. (Most complex design; some parts may not be needed to finish blueprint.)

- Drag a part to the base shown in the Work Area.

- If you drag the right part to the right position, it snaps into place.

- If you drag a part to a wrong position, the part snaps back onto the pegboard. You can try another position or another part.

- Click  for the Discover Mode, or click  to return to Sammy's Main Room.



Workshop

Together Time

Twin Towers

Using a wooden, plastic, or cardboard building block set, play a matching game with your child. (If a building set is not available, use assorted sizes of boxes and cans.) Have your child assemble some of the pieces into an arrangement. Try to duplicate what your child has built. Then, build something for your child to copy.

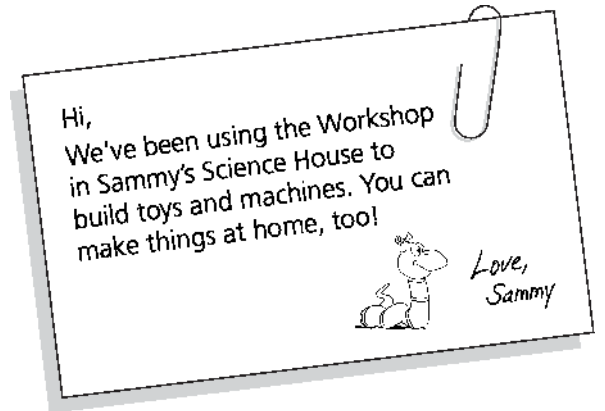

Nature Names

Your child can make a rustic-looking name plaque using a piece of cardboard and several small twigs. If your child knows how to print her name, have her do so in large capital letters on the cardboard. Help trace the first letter with glue. Then, break sticks as needed and place them in the glue to form a twig letter. Repeat the process for each letter. If necessary, weight the project down while it dries. Finally, attach a piece of twine to the cardboard so the name plaque can be hung on a wall or door.



Weather Machine

Overview

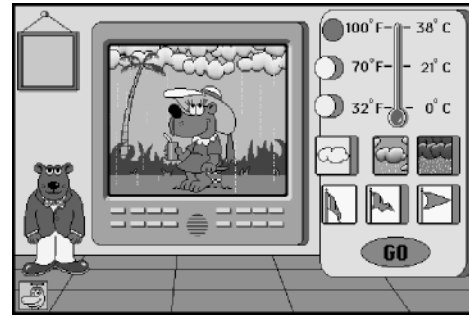

Let's make some weather! When students play with the Weather Machine, they create all sorts of weather. Students choose temperature, moisture, and wind. Then Frederick, the bear, delivers the weather report, and an animation appears illustrating the weather conditions.

Learning Objectives

- Select appropriate variables to indicate key weather conditions
- Know simple weather-related vocabulary, corresponding symbols, and how weather relates to dress

Learning Opportunities

- Discover that different weather conditions result from different combinations of variables
- Notice that changes in one or more key variables cause changes in weather conditions **Together**

Time Activities (page 20)

(To copy and send home)

- Weather Forecaster
- Wind Watch

Curriculum Connections (pages 52–60) ■

Weather Station (Science)

- And Now for the Weather. . . (Creative Dramatics)
- Weather Folklore (Language Arts)
- Moisture Measurements (Mathematics) ■

Temperature Graph (Mathematics)









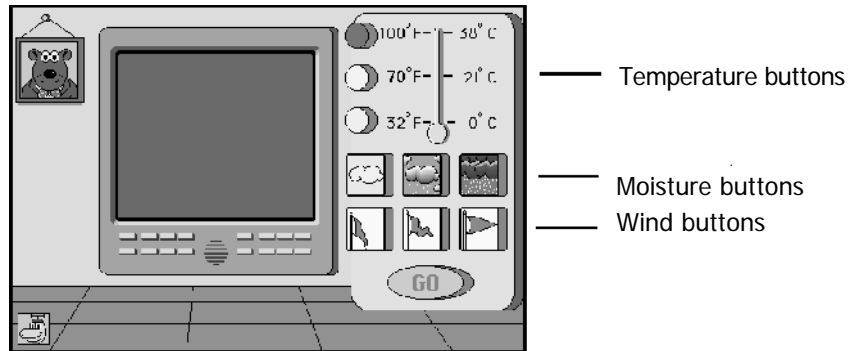

- Wish for a Rainy Day (Art)



Weather Machine Discover Mode

- Click  to enter the Weather Machine from the Main Room.



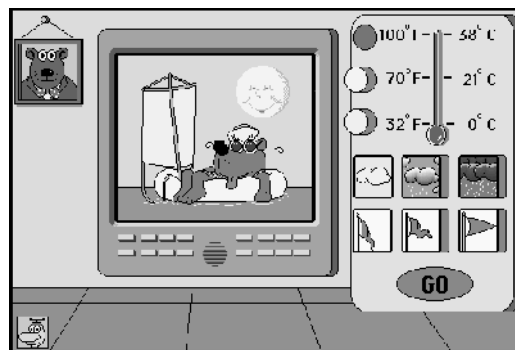

- Click a temperature button for a cold , warm , or hot  day.
- Click a moisture button for a day with no rain or snow , light rain or snow , or heavy rain or snow .
- Click a wind button for a day with no wind , light winds , or strong winds .
- Click  to hear the weather report and to see an animation illustrating the weather.



"Today is hot with no rain and no wind."

- Continue exploring the Weather Machine. Because this is the Explore and Discover Mode, you can try many different weather conditions.

- Click  for the Question and Answer Mode, or click  to return to Sammy's Main Room.



Question and Answer Mode



- Click  to enter the Question and Answer Mode.
- Frederick, the bear, asks you to create a day with specific weather conditions, for example:

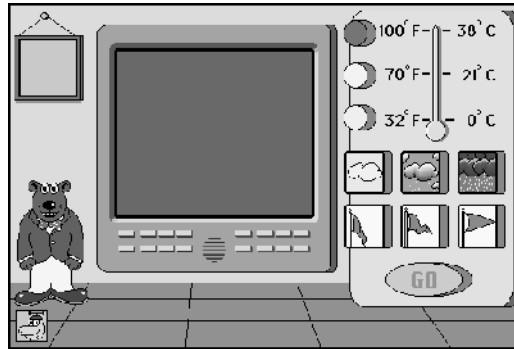

“Can you make a warm day with heavy rain and strong winds?”

(Frederick may ask for one, two, or three weather conditions.)

- Click the Weather Machine button(s) to make the day Frederick requested.



Then, click.

If you forget the weather conditions requested, click Frederick for a reminder.



“Please try again.”

- If you select all the conditions requested, Frederick reports the weather, and an animation about the weather appears.
- If you do not select the weather conditions as requested, Frederick asks you to try again.

- Click  for the Discover Mode, or click  to return to Sammy’s Main Room. :



Weather Machine

Together Time

Weather Forecaster

Have your child predict how many days will be sunny in the next month. Write this number on the calendar. Each sunny day, have your child mark the calendar with a yellow crayon or highlighter. At the end of the month, count up the number of "yellow marked" days with your child. Compare that number with the prediction. Older children may enjoy predicting rainy or snowy days in addition to sunny days. You may want to help your child by discussing seasons, clouds, or typical weather patterns of your region.

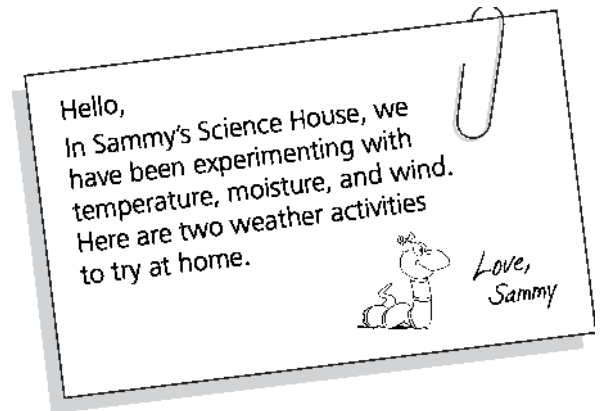

Wind Watch

Help your child make a simple wind indicator. Cut a plastic bread wrapper into strips about an inch wide (starting at the open end and cutting three-fourths of the way up the length of the wrapper). Tie a piece of string tightly around the closed end of the wrapper and then tie the wind indicator to an exposed tree branch. Each day, have your child check the wind indicator and record a symbol, representing the strength of the wind, on the calendar or a chart. For example, sketch the wrapper standing straight out for a strong wind, slightly "furred" for a light wind, and hanging down for no wind. When possible, watch or listen to the weather report at the end of the day and talk about your child's observations in comparison with the weather report.



Sorting Station Overview

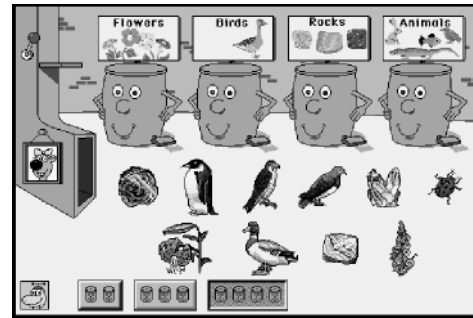

Pictures of plants, animals, fungi, and rocks slide down the chute into the Sorting Station where students sort them into friendly bins. Students hear the names of pictures when they are clicked. When pictures are sorted correctly in the Question and Answer Mode, students are rewarded with humorous animations.

Learning Objectives

- Sort animals and plants by attribute
- Sort animals and plants by scientific classification

Learning Opportunities ■ Discriminate attributes

- Identify similarities and differences among pictures
- Discover how plants and animals are often classified
- Hear and use some common scientific terms
- Observe some attributes that are used in scientific classification
- Hear the names of some plants, animals, rocks, and fungi

Together Time Activities (page 24)

(To copy and send home)

- Groceries Galore
- Magnetic Sorting

Curriculum Connections (pages 61–65)

- Sound Sorting (Music)
- Bin There (Science)
- Falling Leaves (Problem Solving)
- Sort and Recycle (Social Studies)
- Attribute Riddles (Language Arts)
- Grandmother's Favorite Animals (Problem Solving)
- Food Pyramid (Science)



Sorting Station





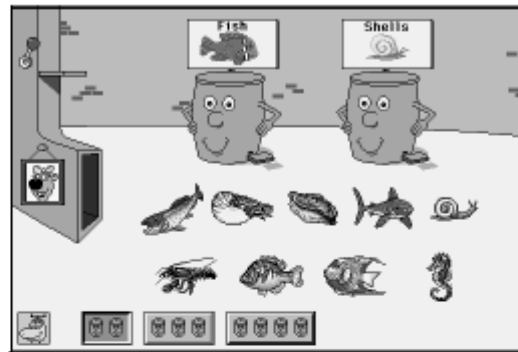





Discover Mode

- Click  to enter the Sorting Station from the Main Room.
- Pictures slide out of the chute for you to sort, and the category for each bin is identified.



"Fish."

"Animals with shells."

- Click a bin  for help in sorting. The pictures that belong in the bin twinkle.
- Click a button , , or  to choose the number of bins.
- Click a sign  to hear a reminder of what belongs in the bin, for example, "Fish."
- Click a picture to hear its name, for example,  "Snail."
- Sort the pictures by dragging them into the bins. Sometimes a picture can be placed in more than one bin.
- Click the pedal on the bin  to see all of the pictures you have placed in that bin.
- Click the lever  on the chute for new categories and pictures to sort. Sort as long as you like.
- Click  for the Question and Answer Mode, or click  to return to Sammy's Main Room.





Sorting Station

Question and Answer Mode

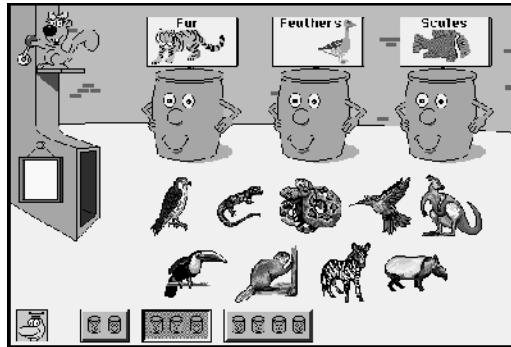

- Click  to enter the Question and Answer Mode.
- Serena, the squirrel, pulls the lever on the chute, and the categories are identified. Then, Serena asks you to help sort.



"Please help me sort."

- Click a button , , or  to choose the number of bins.
- Sort all of the pictures by dragging each one to a bin. Click a sign if you need a reminder of what belongs in the bin.
 - When you put a picture in the correct bin, the bin smiles and thanks you.
 - If you try to put a picture into the wrong bin, you will hear a hint.

When the set of pictures is sorted correctly, the bins will celebrate!

- Click  for the Discover Mode, or click  to return to Sammy's Main Room.



Groceries Galore

On a trip to the grocery store, your child can sort items as you place them in the cart. For a young child, use simple categories such as cans in the back of the cart and boxes in the front of the cart. Other items can go on the lower shelf of the cart. An older child may be able to sort fruits, vegetables, dairy products, meats, etc.

Your child can sort again as you unpack the groceries at home. This time, sort items that go in the refrigerator, items that go in the cupboard, items that go in the freezer, etc.

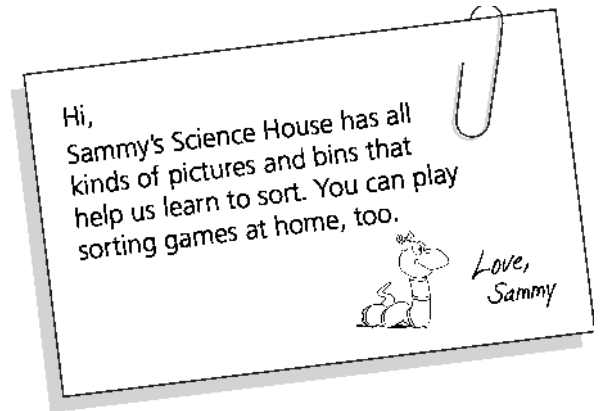

Magnetic Sorting

Note: Because this activity involves small objects, close supervision is advised.

A magnet and the contents of a "junk drawer" can provide an interesting rainy day sorting activity for your child. Designate an area for items that are attracted to the magnet and an area for items that are not attracted to the magnet. Let your child test and sort the items. If you don't have a "junk drawer," gather objects from around your house (paper clip, eraser, rubber band, button, different types of cans, nail, spoon, coins, cloth, pencil, pen, plastic bottle, paper, etc.). Do not use magnets to test video tapes, computer equipment and disks, clocks, watches, or televisions.

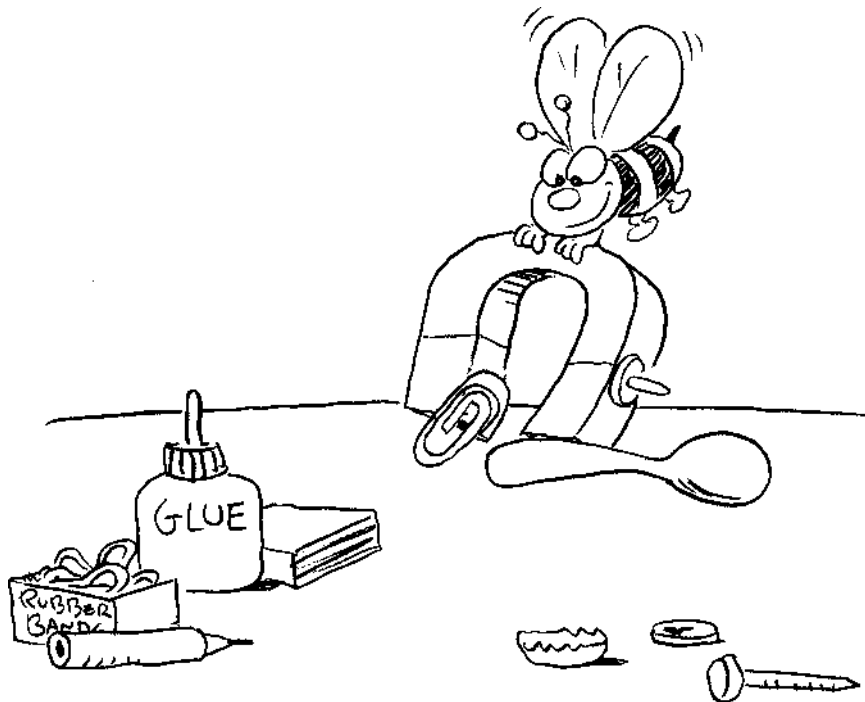

Make-A-Movie Overview

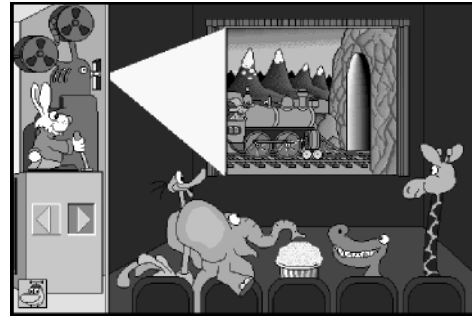

Lights! Camera! Action! Students arrange pictures in sequences to make movies. Students can run their movies forward and backward.

Learning Objectives

- Apply logic to order pictures in series
- Recognize change in physical properties

Learning Opportunities

- Observe differences in a group of related pictures
- Discover that some groups of pictures make sense in more than one order
- Examine a sequence forward and backward
- Explore how things in nature change over time (i.e., lunar eclipse, chrysalis formation, and others)

Together Time Activities (page 28)

(To copy and send home)

- An Organized Day
- First I Was Little

Curriculum Connections (pages 66–73)

- Run the Show (Art)
- Silent Movies (Creative Dramatics)
- 1-2-3 Books (Language Arts)
- Plant Progress (Science)
- First Things First (Social Studies)
- Which Comes Next? (Science)







Make-A-Movie

Question and Answer Mode

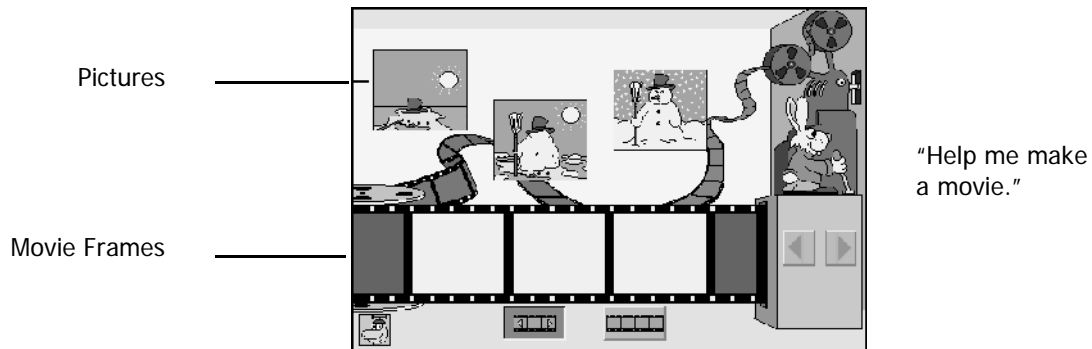

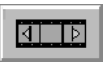
Because only logical sequences will make movies in this activity, Make-A-Movie has a Question and Answer Mode only.

- Click  to enter the Make-A-Movie from the Main Room.
- Ramón, the rabbit, is trying to make a movie and needs your help.

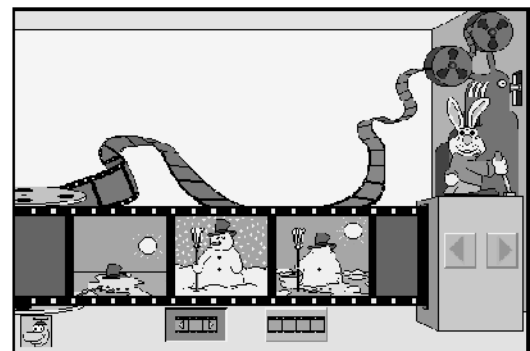
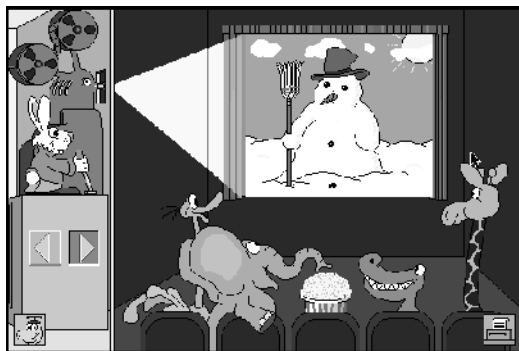

- Click  to make a three-picture movie, or click  to make a four-picture movie.
 - Click  or  to see a new set of pictures.
 - Drag the pictures into the empty movie frames so that the pictures are in sequence. (If you change your mind about the arrangement of the pictures, just drag the pictures again.) Then, click Ramón.
- If the pictures are in sequence, Ramón runs the projector in the theater.
 - If the pictures are not in sequence, Ramón helps you put them into the correct order.



■ To watch the movie run forward in the theater again, click  . To watch the movie run backward, click  .

■ Click  to make a new movie.

■ Click  to return to Sammy's Main Room.



Make A Movie

Together Time

An Organized Day

Help your child organize a part of the day by making a chart. For example, discuss the morning routine and cut out pictures (from magazines or catalogues) which represent the morning activities. Talk about how well different sequences would work. Ask, for example, "Should you brush your teeth before or after breakfast?" Have your child arrange the pictures in the order that would be best for the morning routine and paste them across the top of a white sheet of paper. Then, print the days of the week

along the left side of the paper. Each morning, your child can check off the activities as they are completed.

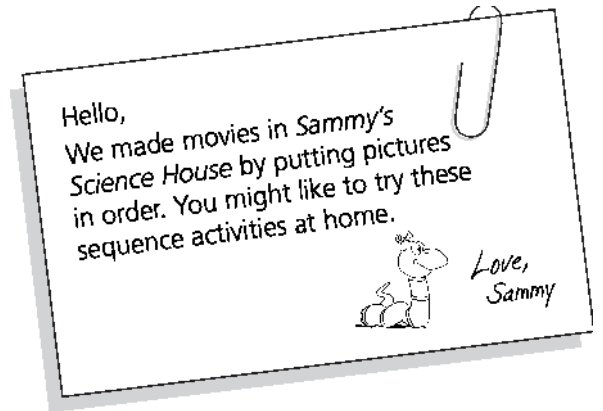

First I Was Little

An afternoon spent sorting pictures with your child will bring back memories and strengthen sequencing skills. Gather unsorted photographs and sit together at a long table. Start with three photographs and ask which came first, second, and third. Lay the photographs on the table in the correct order. Continue the process, ordering three photographs at a time.

As you work together, help your child look for clues in the pictures (changes in a person's height, an outfit that is old or new, a person who has moved away, a person who is new in the neighborhood, season changes, etc.).

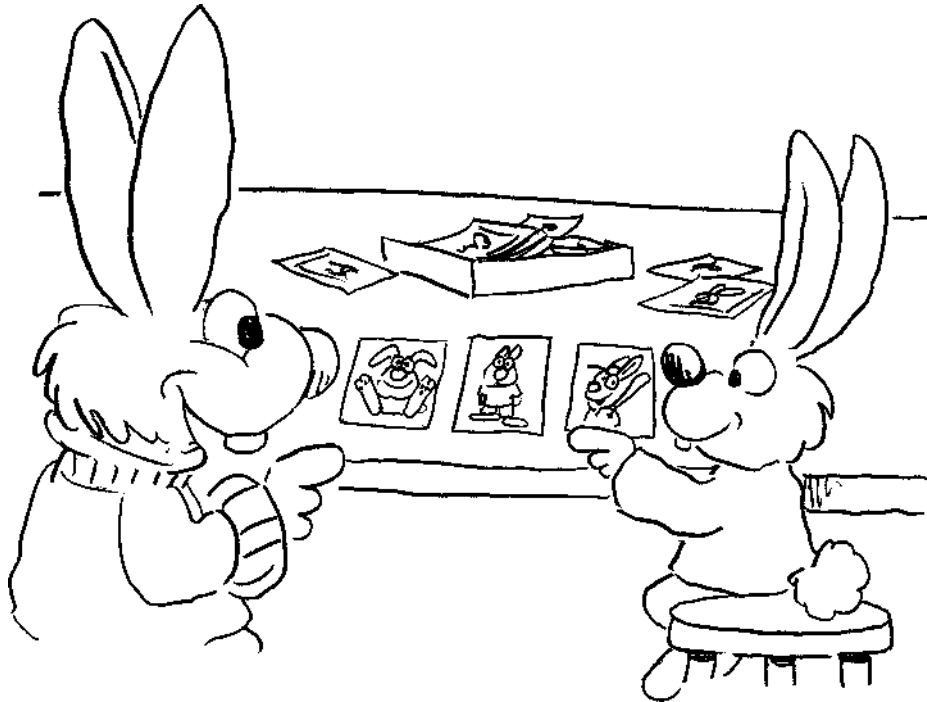

Acorn Pond Overview

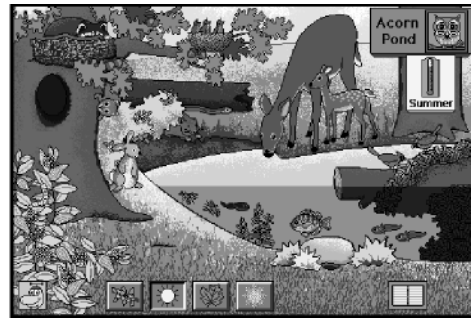

It's spring at Acorn Pond! And summer, autumn, and winter too! Here students see plants and animals as they appear throughout the year, hearing facts about animal growth and behavior. A "Field Notebook" with sketches and interesting information can be printed. Acorn Pond is modeled after a real pond in the upper midwest of the United States.

Learning Objectives

- Identify animals by attributes and habitat
- Recognize seasonal changes

Learning Opportunities

- Discover how specific plants and animals in a particular pond environment change and grow
- Discover how specific animals care for their young
- Infer that all animals have unique needs and habits

Together Time Activities (page 33)

(To copy and send home)

- Nature Expeditions
- Tracking Tracks

Curriculum Connections (pages 74–79)

- Bouncing Butterflies (Art)
- Nature's Colors (Art)
- Under a Log (Science)
- Sammy's Field Notebook (Language Arts)
- Jump Like a Frog (Physical Education)
- Visit a Pond (Science)



Acorn Pond Discover Mode

- Click  to enter Acorn Pond from the Main Room.
- Springtime at Acorn Pond appears.
- Click the pictures on the screen to explore Acorn Pond.

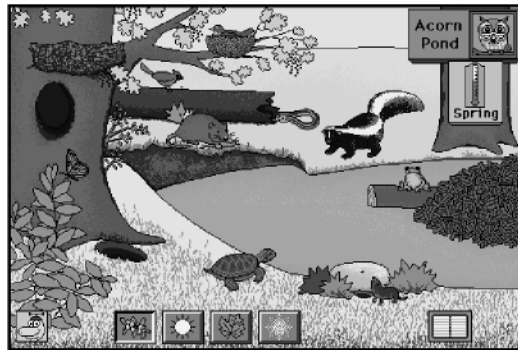

"The Monarch Butterfly lays eggs on a milkweed plant."

- To explore Acorn Pond in another season, click:



Spring

or



Summer

or



Autumn

or



Winter

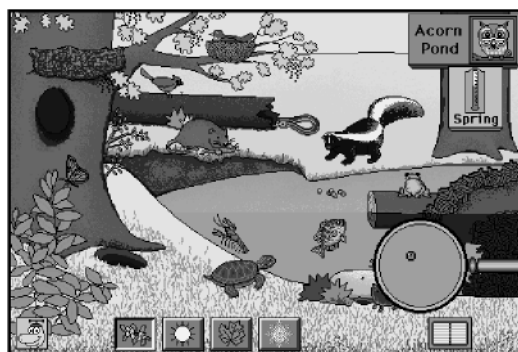

- Click anywhere on the water to discover what is in the pond. Then, click a plant or an animal to see an animation or to hear information.





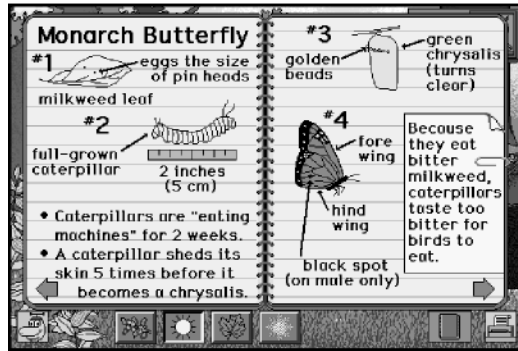

"Salamander eggs hatch into tadpoles with feathery gills."

- Click any animal and then click the Field Notebook  to see notes about that animal.



- To see notes about other animals, click  or .

- Adults may want to read the Field Notebook to children who are not yet reading. It contains interesting facts and helpful sketches.
- Click  to print the notes shown. Once printed, the notes can be colored and used as posters. Or, staple several pages of printed notes together to make a booklet.
- Click  to close the Field Notebook
- Click  for the Question and Answer Mode, or click  to return to Sammy's Main Room.



Question and Answer Mode

- Click  to enter the Question and Answer Mode.
- Olivia, the owl, asks you a question about one of the pond animals, for example:

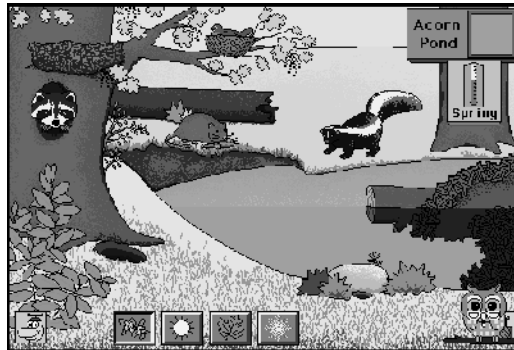

"Whooo lays eggs?"

- Click an animal to answer the question. If you forget the question, click Olivia.
 - If you answer correctly, Olivia tells you, for example, "Right. The robin lays eggs."
 - If you answer incorrectly, Olivia repeats the question, and you can try again.
- To hear questions about the animals of Acorn Pond in another season, click:



Spring

or



Summer

or



Autumn

or



Winter

- Click  for the Discover Mode, or click  to return to Sammy's Main Room.



Acorn Pond

Together Time

Nature Expeditions

Plan special times for you and your child to learn more about the plants and animals in your area. Set up bird feeders made of pine cones covered with peanut butter and bird seed. Take a nature walk in the spring, looking for signs of animal and plant growth. Lay down a circle of yarn and together list all of the living things included in the area, for example, grass, ants, worms, weeds, etc. Once leaves have fallen from trees, take a walk and look for birds' nests.

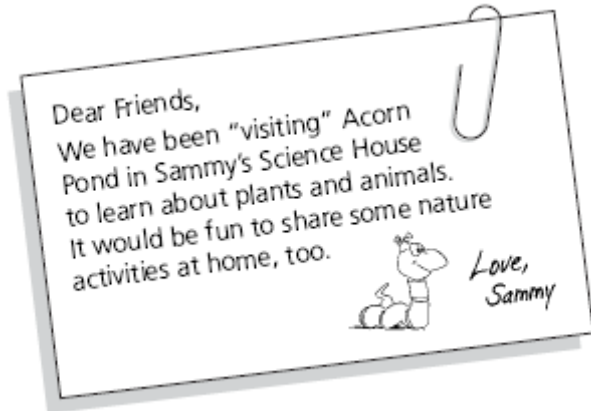

Tracking Tracks

You and your child can have fun with footprints and tracks no matter where you live. Ask all of the family members (pets too) to walk barefoot over a carpet. Then, talk about who left which "tracks." If your carpet doesn't show footprints, you can wet your feet and walk down the sidewalk or driveway, or walk in a sandbox. Or, if you are adventurous, you can put paint on your feet and walk on paper.

Help your child look in the snow or sand for the tracks of animals and people. If possible, have your child sketch the tracks and identify who made them.

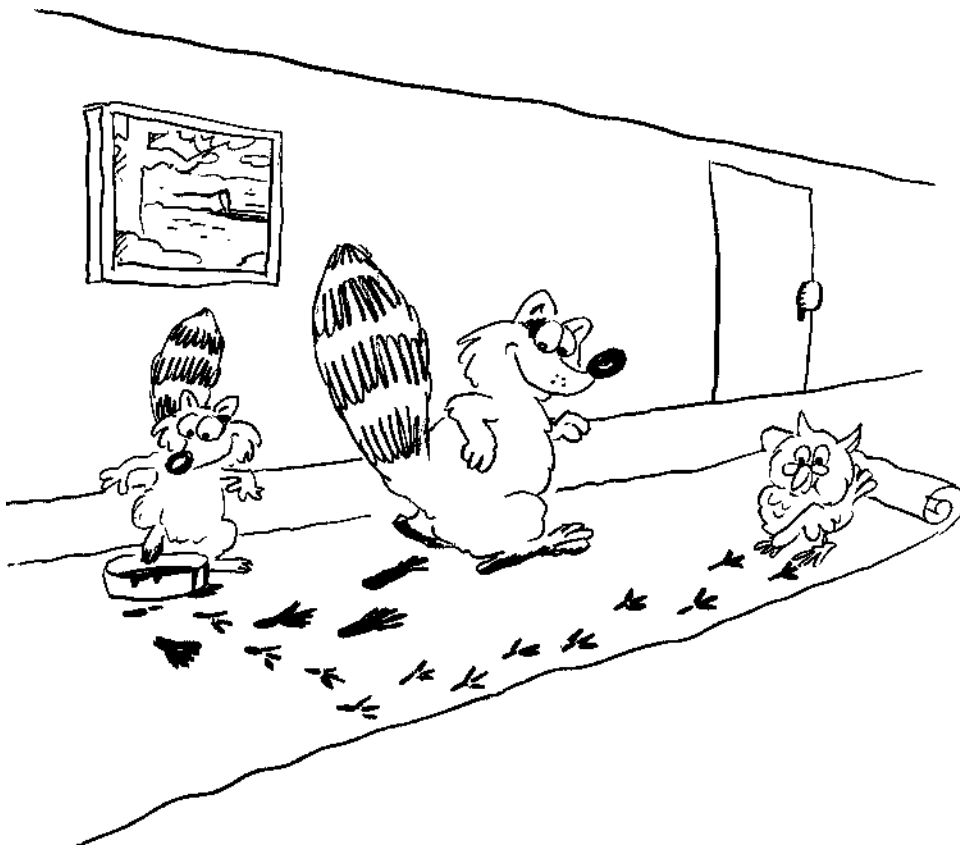

Create-A-Critter

Overview

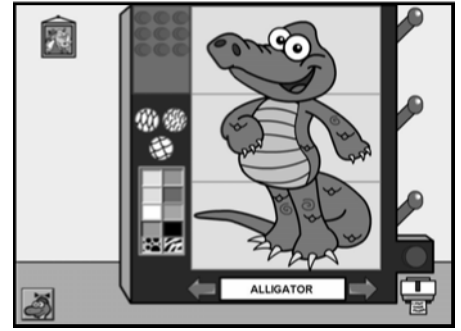

Create a wacky critter with the Create-A-Critter Contraption! Students scroll through different animals to learn about where they live, what sounds they make, what their body covering is, and how they move. Students also get to interchange body parts and body coverings either to make a real animal or one from their imagination.

Learning Objectives

- Recognize that animals have different types of body covering
- Know facts about animals and their habitats

Learning Opportunities

- Group parts of animals by attribute
- Discriminate attributes
- Stimulate creativity by making and naming a unique critter

Together Time Activities (page 37)

(To copy and send home)

- Natural Sing-A-Long
- What Covers You?

Curriculum Connections (pages 80-82)

- Jumbled Jungle (Art)
- Fur, Feathers, or Scales (Mathematics)
- What Animal Am I? (Creative Dramatics)
- Pet Parade (Language Arts)
- Critter Masks (Art)



Create-A-Critter

Discover Mode



Create Your Own Wacky Animals!

Learn about animals—then make your own wacky animals with the Create-a-Critter Contraption!

- Click the Critter Poster to advance to the Create-A-Critter Activity from the Main Room.



"Alligator. Hiss! The alligator has tough scaly skin. He lives in a swamp and can walk on land or swim in water."

- Click the Arrow Buttons to scroll through the different animals. As you do, the labels identify the animal and the narrator provides a brief description of the animal: what sounds it makes, what its body covering is, how it moves, and where it lives.
- Click an SFX Button to hear different animal sounds.
- Click the levers repeatedly to change the heads, bodies, and feet to mix and match body parts to create your own funny animals.
- Click a Coverings Button—fur, scales, or feathers—and your cursor changes to a flood fill icon. Click a body part to fill it in with a covering.
- Click a color, stripes, or spots—your cursor changes to a flood fill icon. Click a body part to fill it in with a color.
- Click the Eraser Button, then click a body part to clear the color or pattern filled.
- When you are finished creating your animal, click the Red Button. The label under the animal is blank. Now you can type in a funny name for your animal.
- Click  for the Question Mode, or click  to return to Sammy's Main Room.





Create-A-Critter

Question and Answer Mode

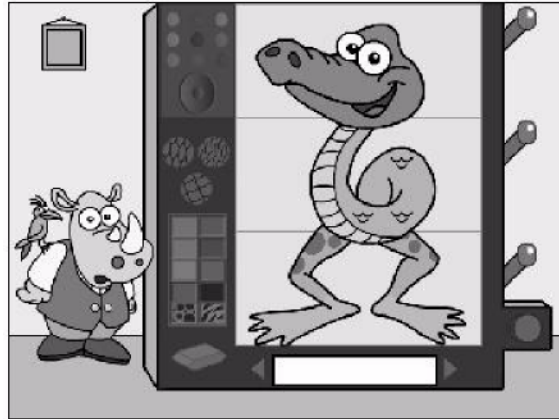
- Click  to advance to the Question and Answer Mode. The animals displayed on the Create-A-Critter Contraption are all jumbled. Rhino and Olivia need help building the real animals.



" I'll give you clues about an animal so you can build it!"

- Click Rhino and Olivia to hear clues about the animal. The order of the clues will be randomly generated:
 - "This animal makes this sound, Hiss!"
 - "This animal has tough scaly skin."
 - "This animal lives in a swamp."
 - "This animal can walk on land or swim in water."
- Click the levers to change the animal parts. Click the Red Done Button when finished.
 - If correct, the animal is identified and it animates. The animal parts shuffle and a new jumbled animal appears.
 - If incorrect, Rhino encourages you to try again. After the second try, he repeats the clues. After the third try and subsequent tries, a correct part appears: head, body, then feet. "This is the animal that Olivia described. (Alligator)."
- Click  for the Discover Mode, or click  to return to Sammy's Main Room.



Create-A-Critter

Together Time

Natural Sing-A-Long

Encourage your child to imitate the sound of an animal and see if you can guess which animal it is. Then you imitate an animal and have the child identify it. Sing songs that include animal sounds such as Old MacDonald and Little White Duck. Listen for bird songs and see if your child can create a song based on the sound of a bird.

What Covers You?

Play the "Feather, Fur, or Scales" game. Name an animal and have your child tell you what kind of body covering it has. Or name a body covering (fur, for example) and have your child name an animal that is covered in fur. Take turns with this game.



Recycle It!

Overview



Help take care of the environment! Students determine if trash is plastic, paper, metal, or glass then place it in the correct recycling bin. They also put food waste and clippings in the compost pile and haul away large recyclable items to clean up the scene.

Learning Objectives

- Identify and sort items for recycling and for compost

Learning Opportunities

- Discriminate attributes

Together Time Activities (page 40)

(To copy and send home)

- Packaging Promenade
- Counting Leftovers

Curriculum Connections (pages 83–87)

- What's Gone! (Social Studies)
- Recycle a Song! (Music)
- Reuzanimals (Art/Science)
- Cleaning the Environment (Mathematics)
- Rework! (Language Arts)



Recycle It! Discover Mode

Learn about Recycling as you sort litter!

Litter is scattered about each scene—bottles, papers, cans, lawn clippings, and more. Sort the trash into the correct bins to clean up each scene.

- Click the Recycling Bin to advance to the Recycle It! Activity from the Main Room. The scene is filled with litter.



- Click a piece of trash (it identifies itself) and drop it into a bin.
 - If correct, it stays there.
 - If incorrect, it pops back into the scene.
- Continue to click and drop trash into the bins or the compost pile to learn how to sort trash for recycling. Click a large item, such as a washing machine, and a truck appears to take it away.
- When all the trash has been removed and sorted, the sorted items transform, showing the items in each bin transforming into new items and the compost pile growing beautiful flowers.
- Click the Arrow Button to go to a different background scene.
- Click  to return to the Main Room.



Recycle It

Together Time

Packaging Promenade

Help your child to become aware of product packaging. Discuss the benefits of the packaging as well as the negatives. After use, ask your child to help organizing the recycling. (Some locations require separation of glass, plastic, and aluminum. In others, "single stream" recycling systems make it possible to use a single recycling container.) Make the point that only clean items should be placed in the recycle container. Children should not handle garbage unless closely supervised by an adult.

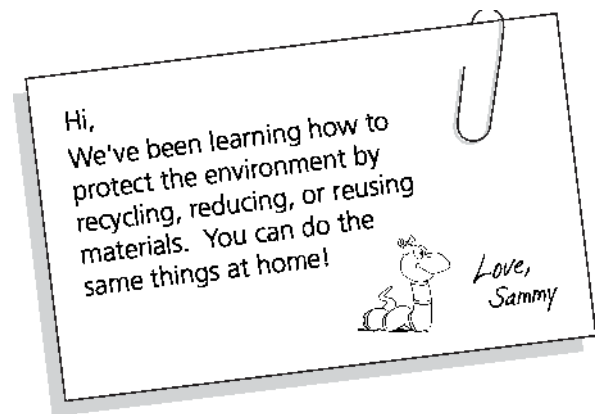

Counting Leftovers

Create a graph that compares the number of glass, plastic, and aluminum packages in your household that go into the recycling system. Use some large paper or cardboard (why not flatten a carton you would be recycling?) and work with your child to outline squares in the necessary columns. Then, each time a package is placed into recycling the child can color a square. At the end of a given time (a week, a month) you can compare the types of packaging that your family are using and determine if it is possible to reduce that number. Keep your eye out for safety—watch cans and bottles for sharp edges.

Curriculum Connections

The learning opportunities in *Sammy's Science House* can be reinforced throughout the school day in many curricular areas. On the following pages, you will find examples of classroom activities designed for kindergarten through second-grade students. The activities may be easily adapted to suit the needs of preschool children. The *Curriculum Connections* activities are grouped according to the corresponding *Sammy's Science House* computer activities (see the chart below).

Some of the *Curriculum Connections* work well before using the corresponding computer activities. Others work well as follow-up experiences. Most can be used before or after students play in the Science House. Pick and choose activities according to your students' needs as well as your computer equipment, facilities, resources, and schedule. There are many different ways to use *Sammy's Science House* and *Curriculum Connections*; use them to stimulate your own imagination as you plan experiences for your students.

Reproducible activity sheets are also included. These can be used in a variety of ways (for student work, transparencies, labels, etc.), some of which are suggested in *Curriculum Connections*. In addition, there are two reproducible pages of Science House characters to use on your chalkboard, bulletin board, or computer.

	Workshop (pages 45–51)	Weather Machine (pages 52–60)	Sorting Station (pages 61–65)	Make-A- Movie (pages 66–73)	Acorn Pond (pages 74–79)	Create-A- Critter (pages 80–82)	Recycle It! (pages 83–87)
Art		<ul style="list-style-type: none"> Wish for a Rainy Day 		<ul style="list-style-type: none"> Run the Show 	<ul style="list-style-type: none"> Bouncing Butterflies Nature's Colors 	<ul style="list-style-type: none"> Jumbled Jungle Critter Masks 	<ul style="list-style-type: none"> Reuzanimals
Creative Dramatics		<ul style="list-style-type: none"> And Now for the Weather ... 		<ul style="list-style-type: none"> Silent Movies 		<ul style="list-style-type: none"> What Animal Am I? 	
Language Arts	<ul style="list-style-type: none"> Living Alphabet 	<ul style="list-style-type: none"> Weather Folklore 	<ul style="list-style-type: none"> Attribute Riddles 	<ul style="list-style-type: none"> 1-2-3 Books 	<ul style="list-style-type: none"> Sammy's Field Notebook 	<ul style="list-style-type: none"> Pet Parade 	<ul style="list-style-type: none"> Reward!
Mathematics	<ul style="list-style-type: none"> Sunshine Time 	<ul style="list-style-type: none"> Moisture Measurements Temperature Graph 				<ul style="list-style-type: none"> Fur, Feathers, or Scales 	<ul style="list-style-type: none"> Cleaning the Environment
Music	<ul style="list-style-type: none"> Kazoo Koncert 		<ul style="list-style-type: none"> Sound Sorting 				<ul style="list-style-type: none"> Recycle a Song!
Physical Education					<ul style="list-style-type: none"> Jump Like a Frog 		
Problem Solving	<ul style="list-style-type: none"> It Moves! 		<ul style="list-style-type: none"> Falling Leaves Grandmother's Favorite Animals 				
Science	<ul style="list-style-type: none"> Buzzy Bee's Bucket Magnifier 	<ul style="list-style-type: none"> Weather Station 	<ul style="list-style-type: none"> Bin There Food Pyramid 	<ul style="list-style-type: none"> Plant Progress Which Comes Next? 	<ul style="list-style-type: none"> Under a Log Visit a Pond 		<ul style="list-style-type: none"> Reuzanimals
Social Studies	<ul style="list-style-type: none"> All Around the Neighborhood 		<ul style="list-style-type: none"> Sort and Recycle 	<ul style="list-style-type: none"> First Things First 			<ul style="list-style-type: none"> What's Gone!

Characters for Bulletin Boards, Computers, and Chalkboards

The illustrations on pages 43 and 44 can be used to call attention to messages on bulletin boards, computers, and chalkboards. Copy, color, and cut out the character. For bulletin boards, slip the character over the edge of the message sign and staple or tape into place. To use the character on the chalkboard, mount the character on the chalkboard and draw a rectangular sign below the character. Then write the information inside the rectangle. These pages can also be reproduced and posted near the computer. You can write in current assignments, notes of encouragement, etc.

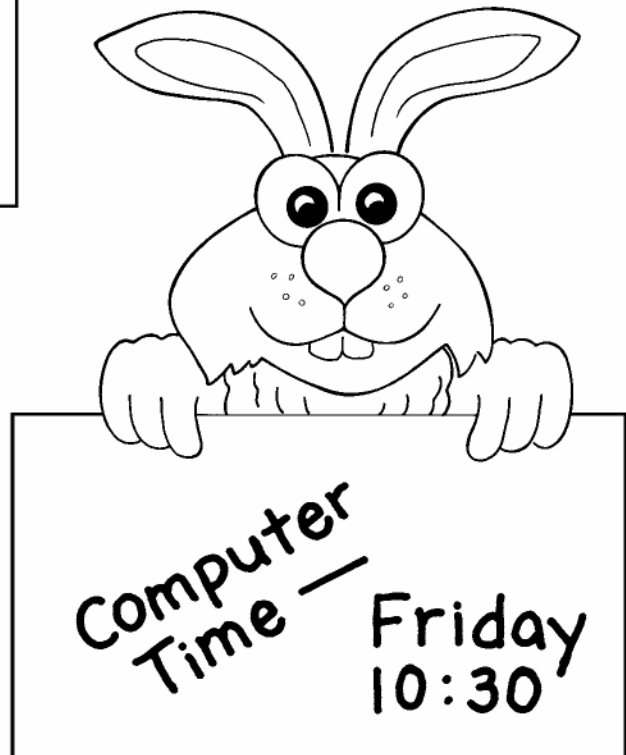

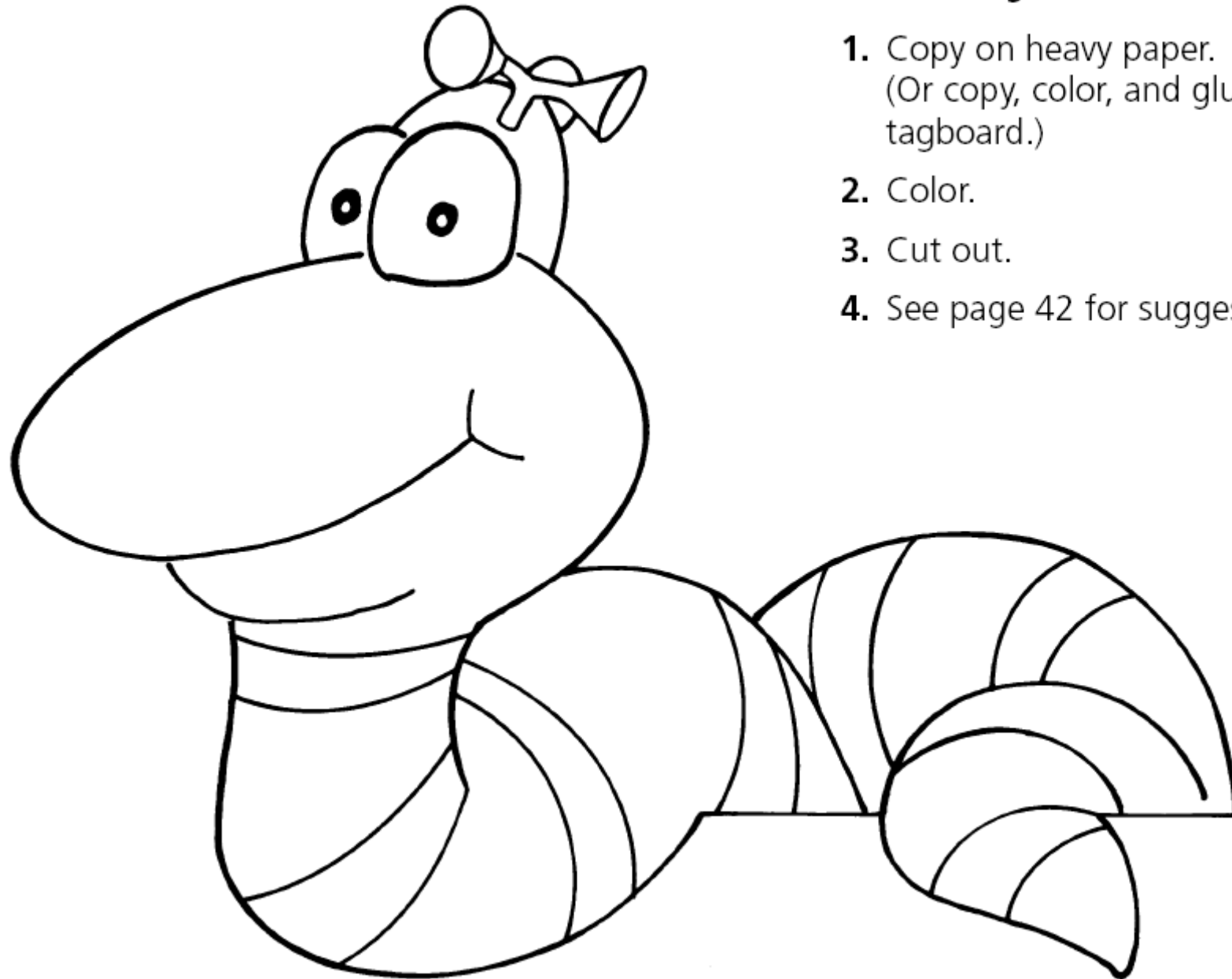

Sammy

1. Copy on heavy paper.
(Or copy, color, and glue to tagboard.)
2. Color.
3. Cut out.
4. See page 42 for suggested uses.

Ramon

1. Copy on heavy paper.
(Or copy, color, and glue to tagboard.)
2. Color.
3. Cut out.
4. See page 42 for suggested uses.

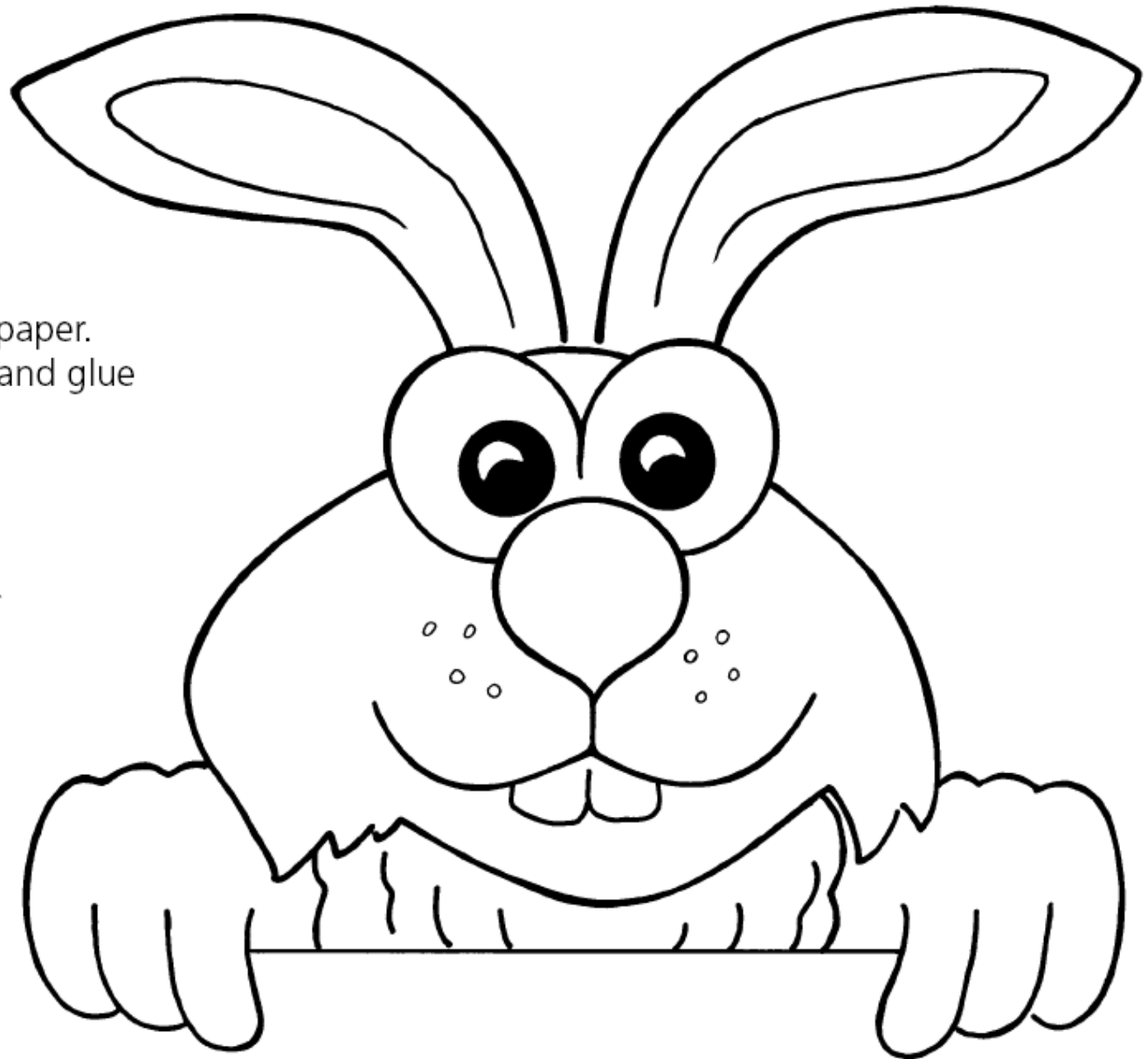

Workshop

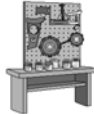

It Moves!

On a supply table, gather sheets and scraps of construction paper, tagboard, egg cartons, pipe cleaners, small lightweight boxes, milk cartons, paper towel tubes, and plastic lids. Explain to students that they will each be making a 3-dimensional construction. The construction must have some part designed to move. To start the flow of ideas, ask students to think of things that move or allow movement (wheels, ramps, pendulums, pinwheels or windmills, spinners, shakers, falling or rolling objects, springs or springy things, hinges, etc.). Suggest that students recall moving objects from the Workshop activity in *Sammy's Science House*:

Problem Solving

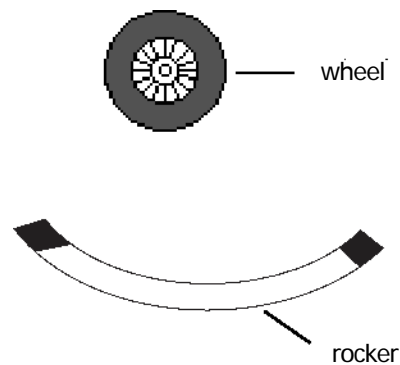
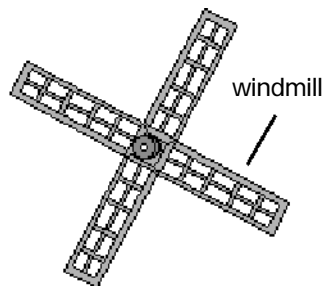
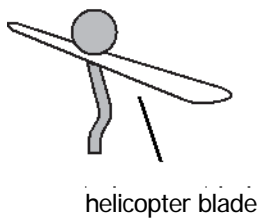

When their creations are complete, let students show them and tell how they “work.”

Living Alphabet

Make copies of page 49 for your students. Point out the example at the top of the page of the letter made with stick people.

Let students draw stick figures to make the other letters on the page. Once the student sheets are done, take them to the gym and let students pose like the stick figures to make living alphabet letters. For safety, establish the rule that all letters must be formed while lying on the floor. Do not allow students to lift each other or to support each other's weight. Once students have formed several alphabet letters, they may want to try spelling out words or short messages.

Language Arts

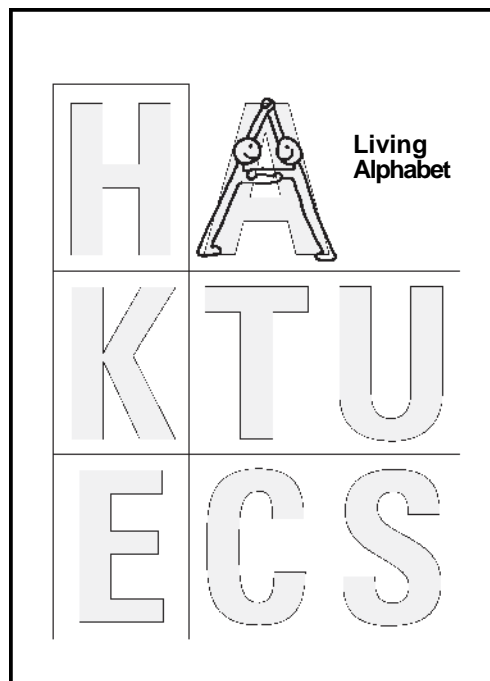

Kazoo Concert

Music

For this project, you will need wax paper, rubber bands, and cardboard tubes. Use tubes from toilet tissue or longer tubes cut to about 5 inches. Give copies of

page 50 to your students. (Alternatively, make a transparency from page 50 for the class to use together.)

If students are not familiar with kazoos, explain that kazoos are musical instruments played by humming into the open end. Go over the steps on the activity sheet together before students construct their kazoos. Point out that when we make something, we usually need to start with the supplies (Step 1), use the supplies to prepare the parts (Step 2), and, finally, use the parts to assemble the finished project (Step 3). You may want to suggest that students work in pairs or get help from you on Step 3 (putting on the rubber band while holding the wax paper in place).

When the kazoos are finished, let students experiment with playing them for a few minutes. Then treat yourselves to a “Kazoo Concert” by playing the students’ favorite familiar songs together.

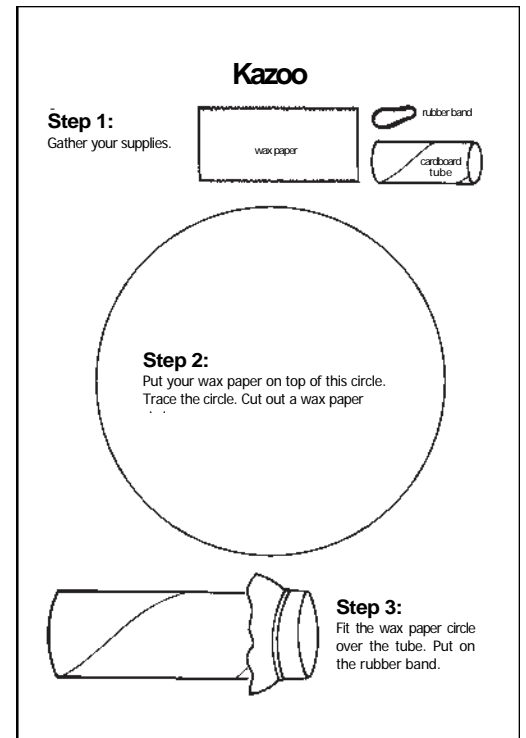

Sunshine Time

Mathematics

As you teach students about time and recording time, talk about sundials and how they work. On the chalkboard, draw plans for a simple sundial, explaining the parts as you draw. Let students work in small groups to make their own sundials.

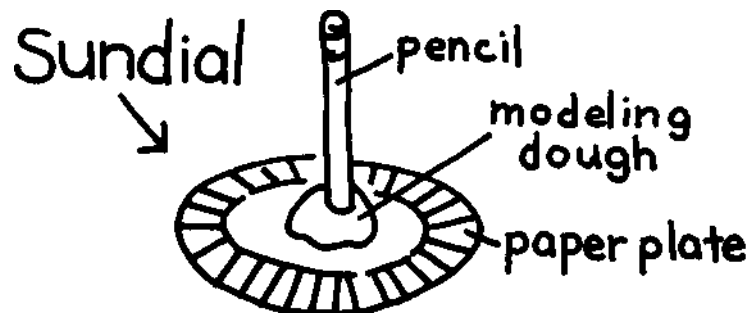

Put the sundials in a sunny spot where they will not need to be moved for several days. Show the students how to write the time on the rim of the plate at the point where the pencil casts its shadow:

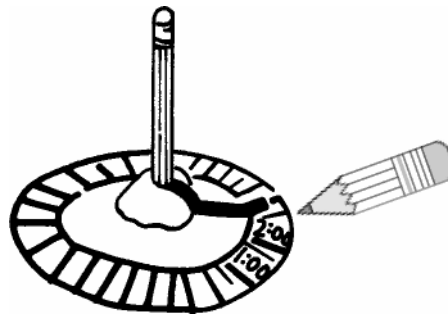

Students may choose to mark their sundials with every hour (1:00, 2:00, etc.), with significant times (12:15-lunch, 1:00-PE class, etc.), or with random times (1:16, 2:35, etc.).

All Around the Neighborhood

Social Studies

Gather pictures of various buildings in your community (courthouse, school, library, community center, stores, homes, etc.). Possible sources include visitor guides, local postcards, newspaper photos, and snapshots. With the students, discuss these buildings and their uses in your community. Use a roll of white paper to cover a spare table or other similar-sized area. On the paper, work together to draw an aerial view of your community. It is not important to be totally accurate, but do include some streets and mark the location of your school and some of the buildings you discussed:

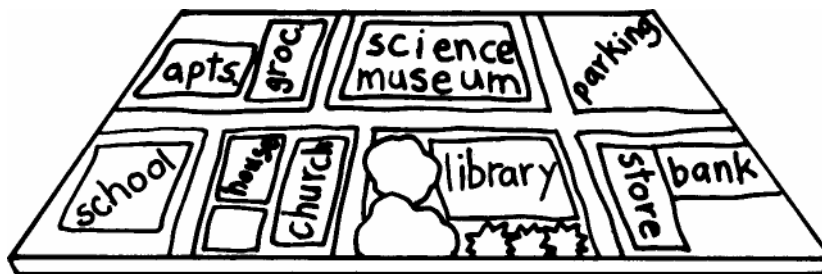

Using the pictures you gathered as guides, let students construct the buildings from milk cartons, cans, small boxes, and plastic building blocks. Students may enjoy bringing small toy cars from home to drive around your model community.



Buzzy Bee's Bucket Magnifier

Science

With this activity, students gain experience following plans, discover how magnifying lenses work, and create magnifiers that can be used to examine small objects. After students have had an opportunity to play with Buzzy, the bee, in the Workshop activity of *Sammy's Science House*, divide the class into small groups and give each group a copy of page 51.

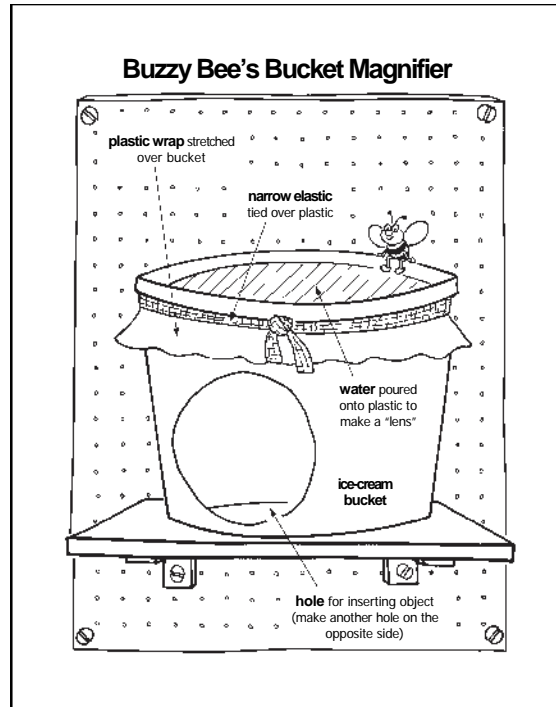

Help students as needed to follow Buzzy's plans for building bucket magnifiers. (If you anticipate a need for additional direction, make a transparency from page 51 and discuss the construction process together before students begin.) Students will be able to use scissors to cut the holes in their buckets themselves if the buckets are made of fairly soft plastic and if you punch the initial hole for them.

You may want to move outdoors when it is time to add the water so that no water spills in the classroom. Slowly pour as much water as possible onto the plastic, which will sag into the shape of a lens. Examine objects from nature (leaves, rocks, etc.) by putting them through one of the holes cut in the side of the bucket and looking at them through the water lens.

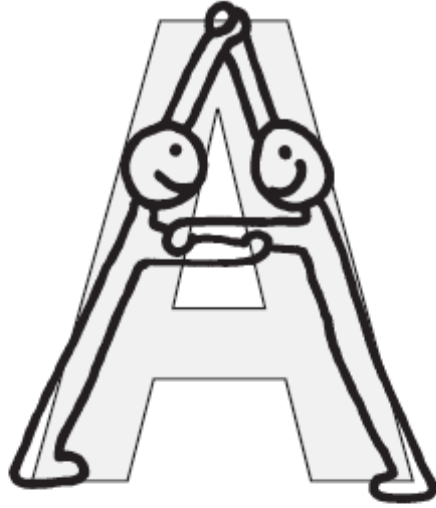
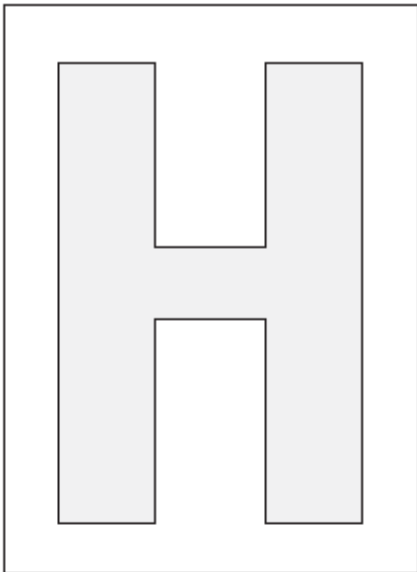

Living Alphabet

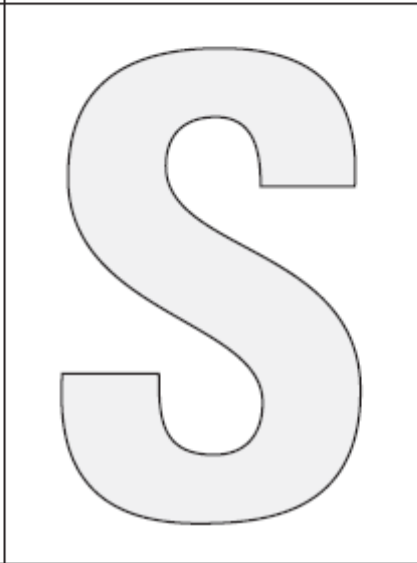
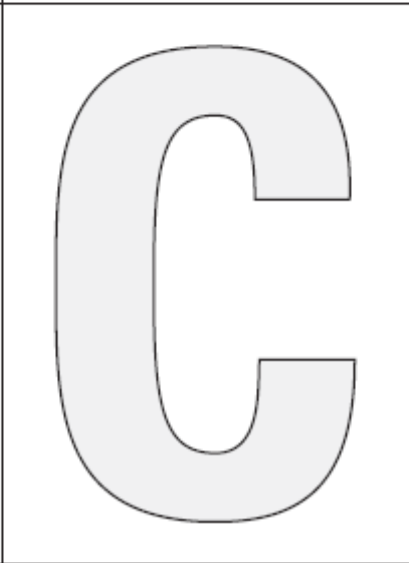
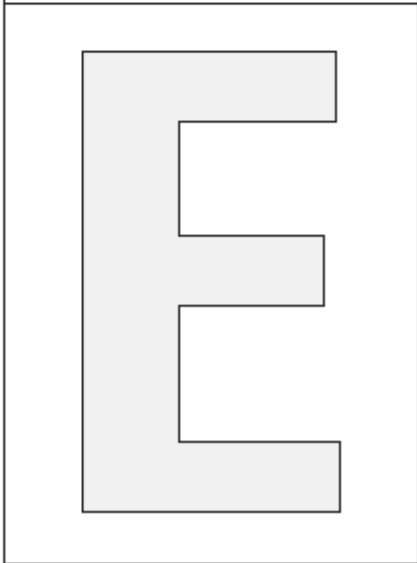
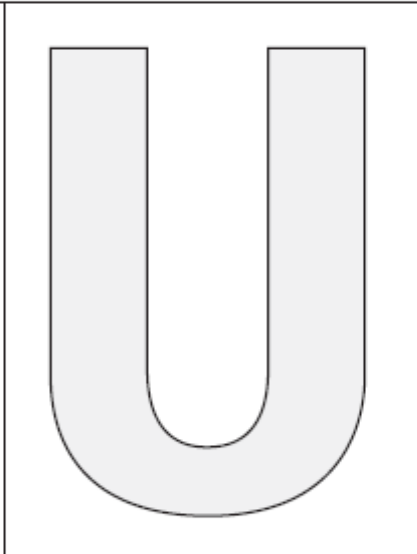
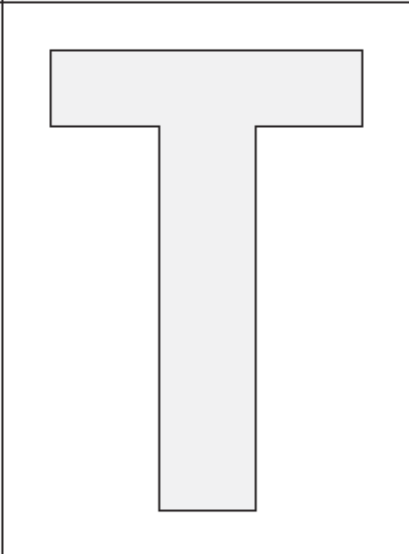
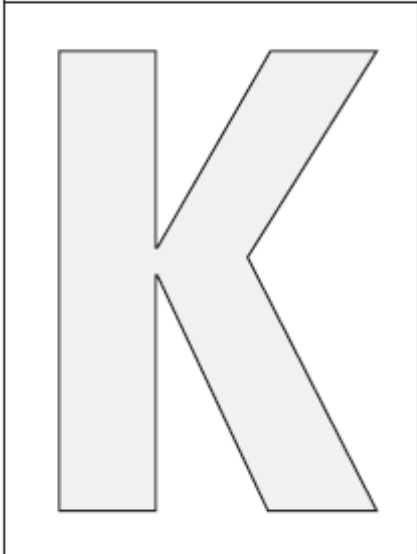

Use with "Living Alphabet" (page 45).

Kazoo

Step 1:

Gather your supplies.

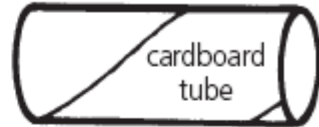

Step 2:

Put your wax paper on top of this circle.
Trace the circle. Cut out a wax paper circle.

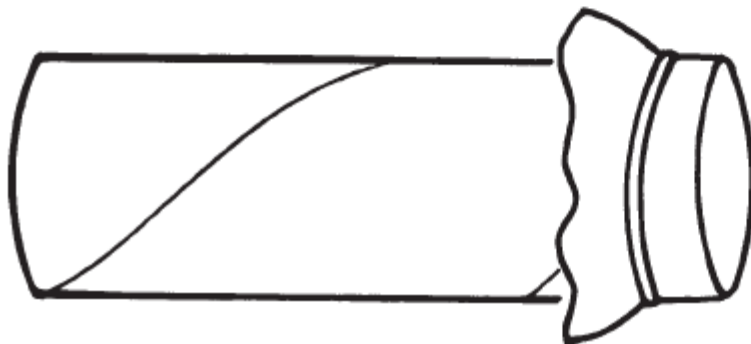
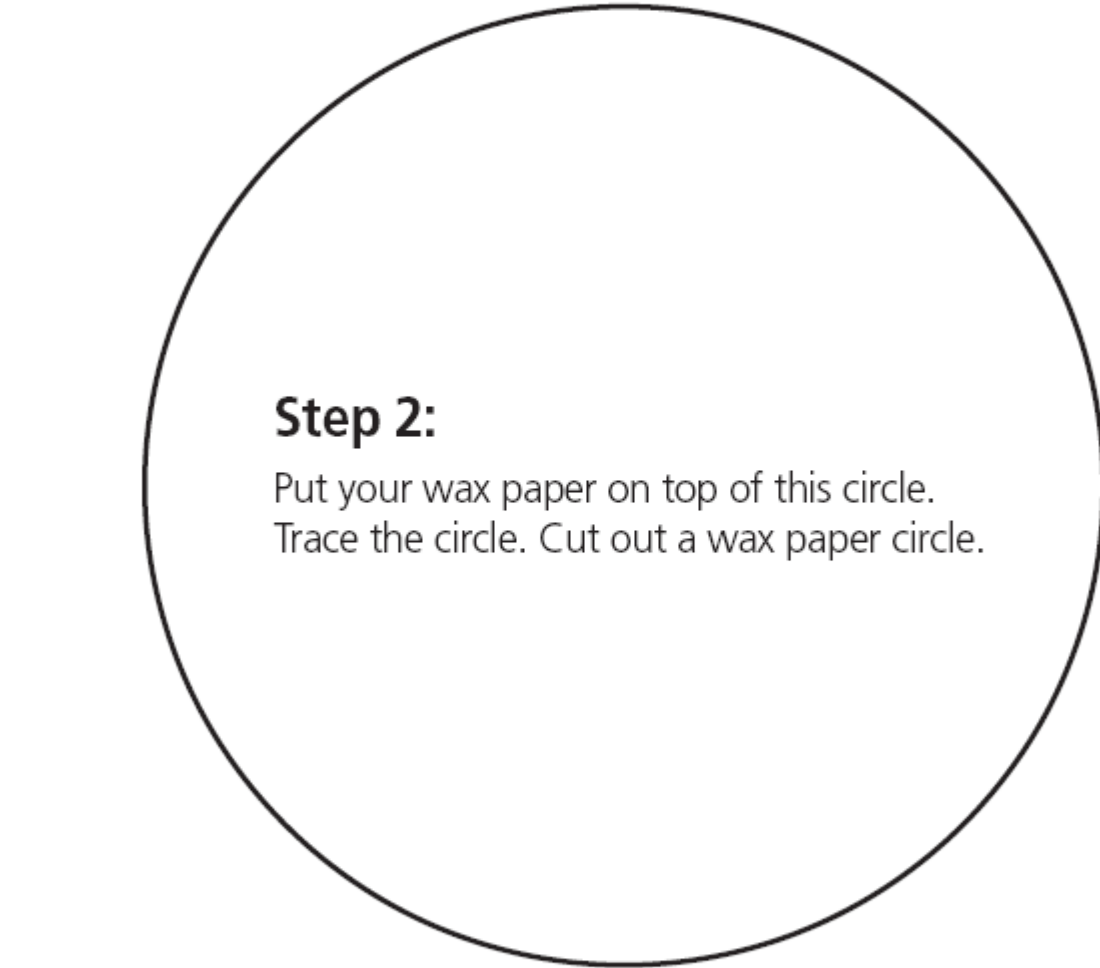

Step 3:

Fit the wax paper circle
over the tube. Put on
the rubber band.

Use with "Kazoo Koncert" (page 46).

Buzzy Bee's Bucket Magnifier

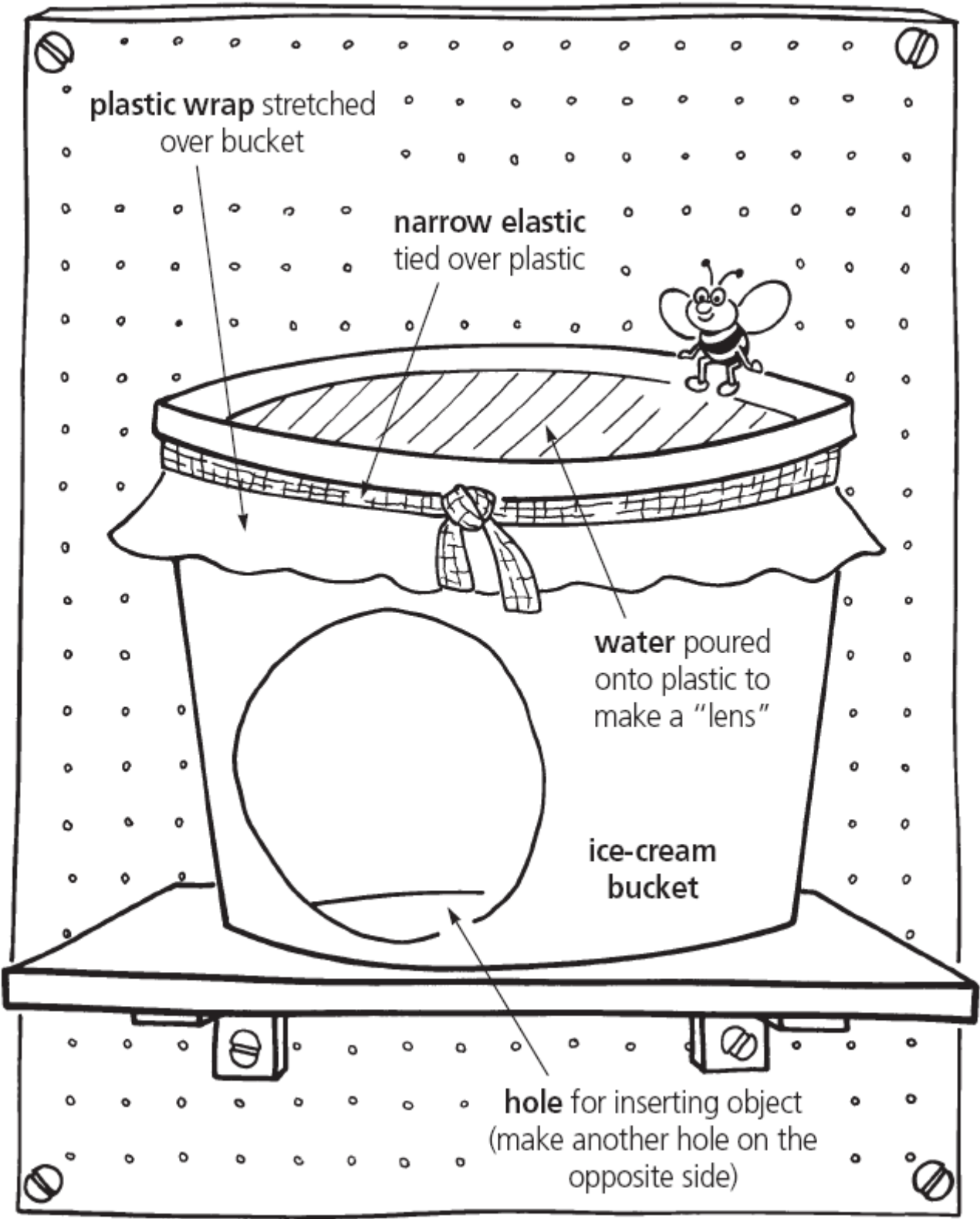

Use with "Buzzy Bee's Bucket Magnifier" (page 48).

Weather Machine

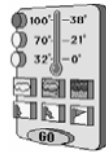

Weather Station

Science

Have students work in small groups to make simple weather instruments for a classroom "weather station." Instructions for making a wind indicator, rain gauge, and thermometer are included on pages 56, 57, and 58.

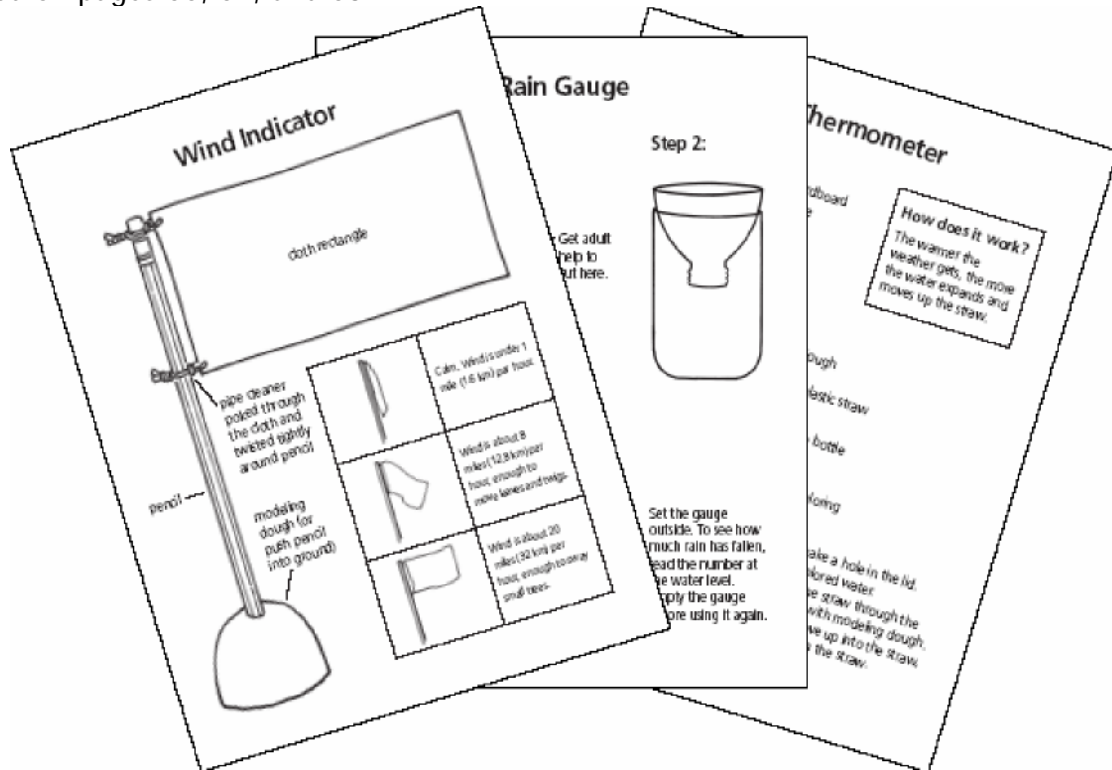

When the instruments are completed, ask students to explain the instruments and how they work to the class. Have each group take readings daily. Use simple symbols to keep a record of the weather conditions on a large chart or calendar:

Tuesday	Wednesday	Thursday	Friday
1	2	3	4

If students want to make their own weather stations at home, provide them with copies of pages 56, 57, and 58.

And Now for the Weather. . .

Over a period of about one month, let each student have a turn at being a weather reporter. The necessary weather information can be gathered by reading the instruments in your weather station ("Weather Station," page 52) and by using the newspaper weather column or radio and television reports. Make a transparency from page 59 and demonstrate how to use the form to record weather information. Current weather conditions are recorded at the top of the form and the forecast at the bottom of the form.

Each day, have the designated reporter fill in a copy of page 59 and use it to give the weather report from a "broadcasting studio" set up in your classroom. In the studio, you might want to include a small table or desk, a map of your state or the United States, a sign with a name for the broadcasting station, and a

"microphone" made from a cardboard tube and a ball:

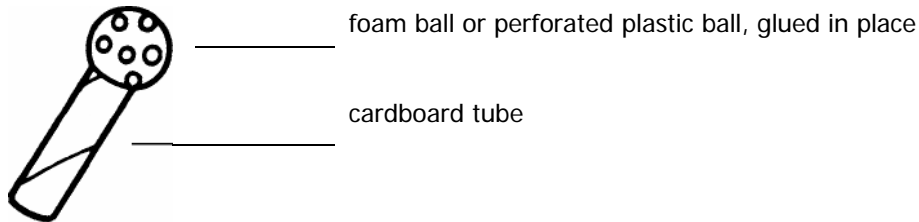

foam ball or perforated plastic ball, glued in place

cardboard tube

Creative Dramatics

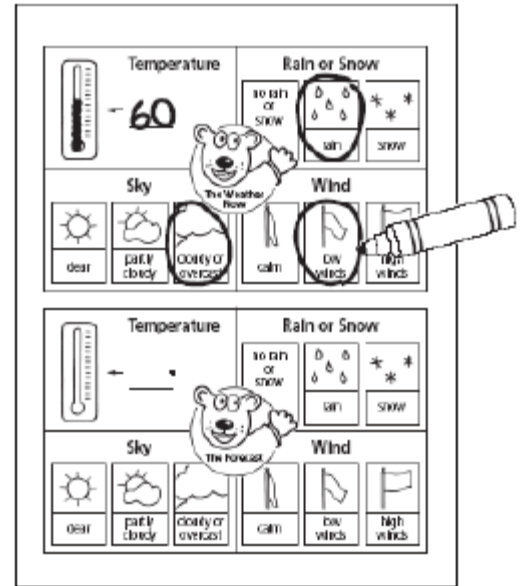

Weather Folklore

Ask a student volunteer to relate the story of Groundhog Day. (If the groundhog comes out of its burrow on Groundhog Day and sees its shadow, there will be 6 more weeks of winter. If the groundhog casts no shadow, there will be an early spring.) Explain that folklore has often been used to predict the weather, and that sometimes there may be some truth to weather folklore. In the United States, many sayings about the weather originated with the early settlers in New England and often quite accurately reflect the weather patterns in that part of the country.

Cut apart the sayings on page 60. Give each student a saying to paste to the bottom of a 12 x 18-inch sheet of drawing paper. Let students illustrate their sayings.

Language Arts

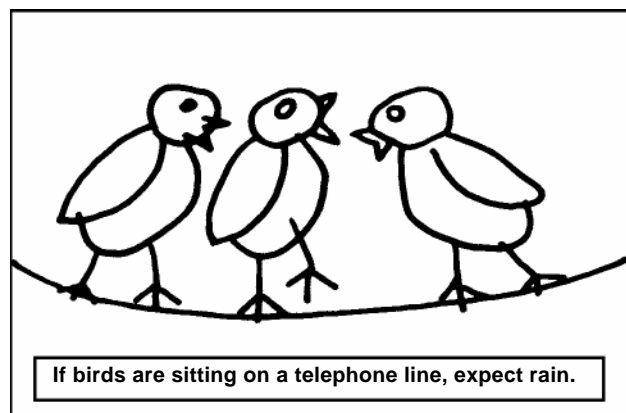

Suggest that during the next few days, students use their own observations as well as opinions gathered from their parents, other adults, and classmates to determine if their sayings contain elements of truth. Then let students share their illustrations and conclusions with the class. Students may want to include their thoughts on how the sayings might have originated as well as thoughts about whether the sayings might be true in other geographic locations.

Moisture Measurements

Mathematics

Let students put their measurement skills to use in exploring one or both of the following weather questions:

Question: How many inches of water are in a 5-inch (12.5 cm) snowfall?

Supplies: plastic bucket (about 5-quart size)
ruler
masking tape
marker
small shovel or scoop

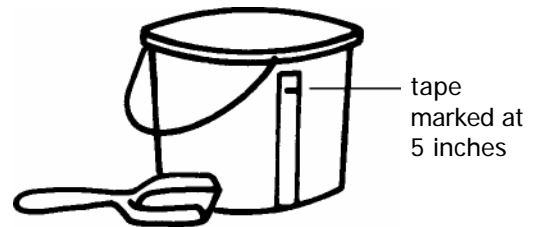

Procedure: On the outside of the bucket, run a strip of masking tape from top to bottom. Set the bucket on the floor and use the marker to mark a point on the tape 5 inches (12.5 cm) up from ground level. Fill the bucket with 5 inches of snow. If possible, scoop freshly fallen snow from an undisturbed spot. Take the bucket inside and let the snow melt. Mark the water level on the tape. Measure from ground level as before to determine the amount of water in 5 inches of snow.

Question: Will an 8-ounce (240 ml) puddle evaporate faster in the sun or in the shade?

Supplies: 2 plastic buckets or bins of the same size and shape
measuring cup

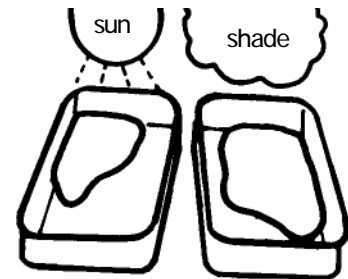

Procedure: Pour an 8-ounce (240 ml) "puddle" of water into each plastic container. Set one in a sunny location (in the classroom or outside) and the other in a location that will remain in the shade. Periodically, measure the remaining water in each container to determine which is evaporating faster. (You can try a similar experiment with real rain puddles by measuring their diameters periodically as they evaporate.)

Temperature Graph

Mathematics

For this activity, you will need a thermometer mounted outside your classroom window or a thermometer that can be placed outside for a short period of time each day. Also, prepare a large grid to use as a bar graph, writing the dates for the next 10 school days at the bottom and numbers representing the expected range of temperatures at the side.

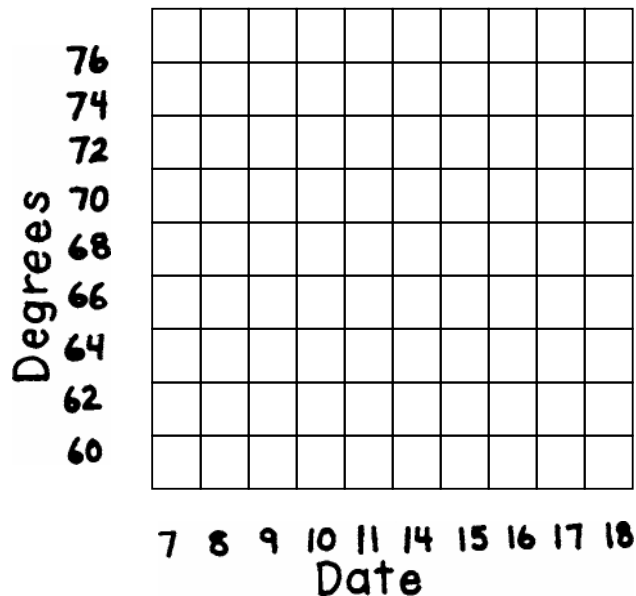

For the next 10 school days at approximately the same time each day, have students use the thermometer to read the outside temperature. On the graph, help students record the temperature by coloring the bar above the day's date. When the graph is complete, work with students to draw some conclusions about the data. For example, identify the highest temperature recorded, the lowest temperature recorded, the temperature that appears most frequently, and any general trends toward warmer or cooler temperatures over the time period.

Wish for a Rainy Day

Art

You can do the first step of this project anytime, but you'll have to wait for a rainy day to complete it. Provide white drawing paper and tempera paint. Instruct students to fill their papers with large colored shapes. Their creations can be free-form or geometric, realistic or imaginary, but small detail should be avoided.

Put the paintings aside and wait for a rainy day. Ask students to listen to the weather forecasts at home and let you know when to expect rain. On the first rainy day, let students take turns at an open window or door, holding their paintings outside for just a moment. Keeping the paintings horizontal at all times so that the paint doesn't run, have students place them on a table or on the floor to dry. When the paintings are dry, display them and point out the interesting patterns created by the rain.

Wind Indicator

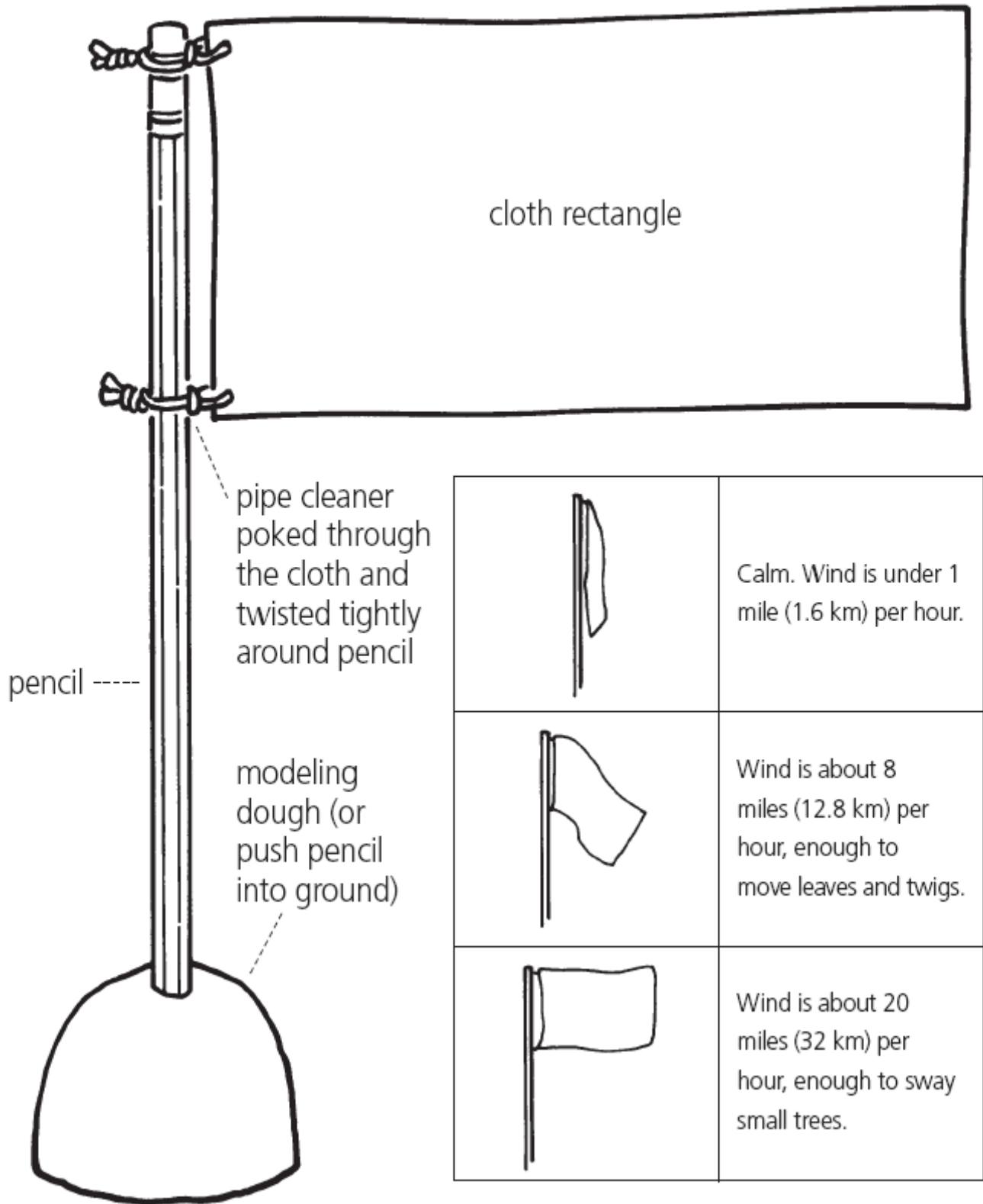

Use with "Weather Station" (page 52).

Rain Gauge

Step 1:



Step 2:

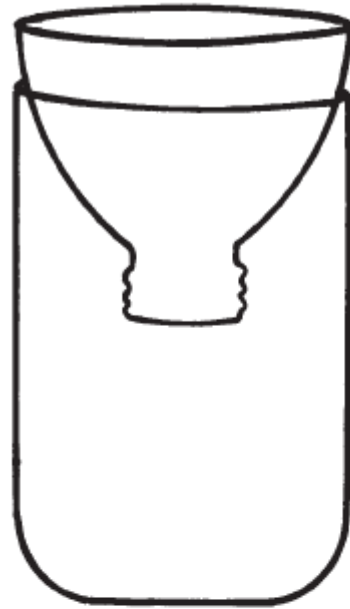

Step 3:

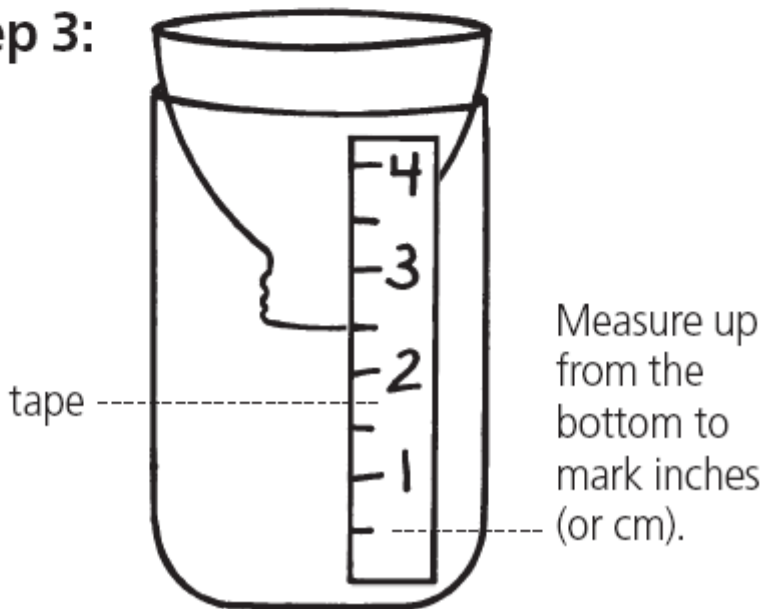

Set the gauge outside. To see how much rain has fallen, read the number at the water level. Empty the gauge before using it again.

Thermometer

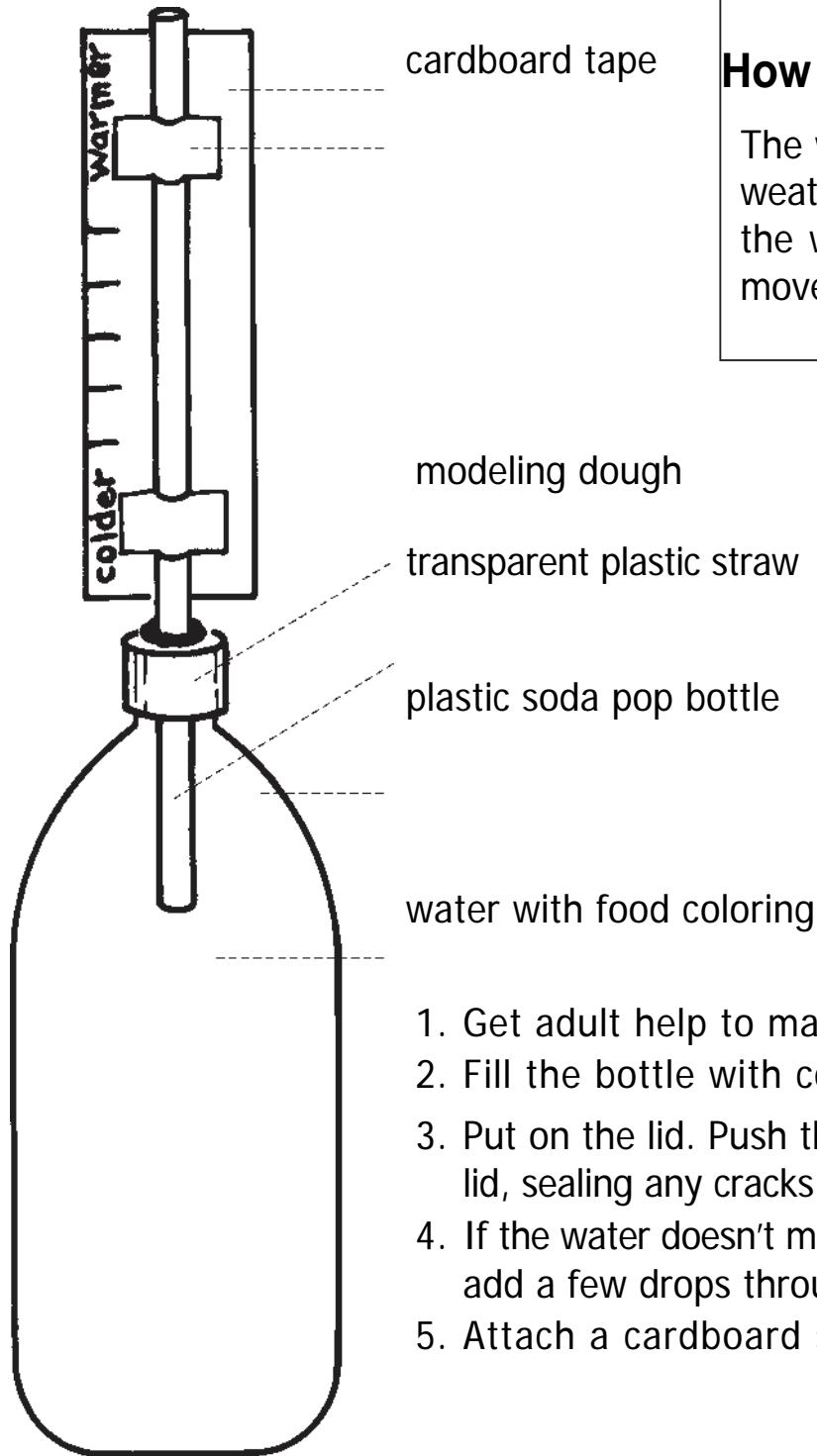





















































How does it work?

The warmer the weather gets, the more the water expands and moves up the straw.

1. Get adult help to make a hole in the lid.
2. Fill the bottle with colored water.
3. Put on the lid. Push the straw through the lid, sealing any cracks with modeling dough.
4. If the water doesn't move up into the straw, add a few drops through the straw.
5. Attach a cardboard scale.

Use with "Weather Station" (page 52).

 <h3>Temperature</h3> <p>← °</p> <p>_____</p>			<h3>Rain or Snow</h3> <table border="1"> <tr> <td>no rain or snow</td> <td></td> <td></td> </tr> <tr> <td></td> <td>rain</td> <td>snow</td> </tr> </table>			no rain or snow				rain	snow						
no rain or snow																	
	rain	snow															
 <p>The Weather Now</p>																	
<h3>Sky</h3> <table border="1"> <tr> <td></td> <td></td> <td></td> </tr> <tr> <td>clear</td> <td>partly cloudy</td> <td>cloudy or overcast</td> </tr> </table>						clear	partly cloudy	cloudy or overcast	<h3>Wind</h3> <table border="1"> <tr> <td></td> <td></td> <td></td> </tr> <tr> <td>calm</td> <td>low winds</td> <td>high winds</td> </tr> </table>						calm	low winds	high winds
																	
clear	partly cloudy	cloudy or overcast															
																	
calm	low winds	high winds															

 <h3>Temperature</h3> <p>← °</p> <p>_____</p>			<h3>Rain or Snow</h3> <table border="1"> <tr> <td>no rain or snow</td> <td></td> <td></td> </tr> <tr> <td></td> <td>rain</td> <td>snow</td> </tr> </table>			no rain or snow				rain	snow						
no rain or snow																	
	rain	snow															
 <p>The Forecast</p>																	
<h3>Sky</h3> <table border="1"> <tr> <td></td> <td></td> <td></td> </tr> <tr> <td>clear</td> <td>partly cloudy</td> <td>cloudy or overcast</td> </tr> </table>						clear	partly cloudy	cloudy or overcast	<h3>Wind</h3> <table border="1"> <tr> <td></td> <td></td> <td></td> </tr> <tr> <td>calm</td> <td>low winds</td> <td>high winds</td> </tr> </table>						calm	low winds	high winds
																	
clear	partly cloudy	cloudy or overcast															
																	
calm	low winds	high winds															

Use with "And Now for the Weather..." (page 53).

Weather Folklore

Fireflies come out before a rain.
A rainbow in the evening means fair weather is on the way.
When bees stay near the hive, rain is close by.
When muskrats build large houses in deep water, it will be a cold winter.
Expect stormy weather when ants travel in a straight line. When they scatter all over, the weather is fine.
If a dog pulls its feet up when walking, expect a change in weather.
The higher hornets build their nests, the higher the snow will be.
Rabbits leave the field and head for the woods before a rain.
If birds are feeding during a rain, it will rain all day.
The faster a cricket chirps, the warmer the weather.
Clover leaves show their bottom sides before a rain.
If birds are sitting on a telephone line, expect rain.
Red sky in the morning, sailors take warning. Red sky at night, sailor's delight.
Ant mounds will be heaped up before a rain.
The higher the clouds, the fairer the weather.
Small snowflakes mean a long snow. Large snowflakes show the snow won't last.

Frogs croak before a rain, But in the sun are quiet again.
Fish bite before a rain.
A ring around the moon or sun Means that rain will surely come.
The wider the brown band on Woolly Bear Caterpillars, the milder the winter will be.
Cattle huddle together before a storm.
Rain before seven, Clear by eleven.
Cats and dogs eat grass before a rain.
When the wind is in the west, Fishing is the best.
Ducks quack louder before a storm.
The daisy shuts its eye before a rain.
The more nuts squirrels gather in autumn, the colder the coming winter.
Flowers smell best before a rain.
Doors and drawers stick before a rain.
After the robin comes in spring, he will get snow three times on his back.

Sorting Station



Sound Sorting

The next time your class uses rhythm instruments, try incorporating sorting activities. For example, separate the metal instruments from the non-metal instruments. Let students play both. Is there a difference in the sound? Have students make up categories. Some possibilities include:

one-piece instruments — two-piece instruments
instruments played by shaking — instruments played by tapping
high-pitched instruments — low-pitched instruments
big instruments — little instruments
instruments that make loud sounds — instruments that make soft sounds

Music

Bin There

Let students cut pictures of animals out of old magazines. Copy page 64 and make 2 labels (for example, “wings” and “no wings”). Use clothespins to attach the labels to 2 plastic bins. As a class, sort the pictures into the bins. Another time, make new labels for the bins and resort the pictures. Let students suggest appropriate labels such as:



baby — adult
furry — not furry
2 legs — 4 or more legs
water animal — land animal
stripes — no stripes



Try playing “in reverse.” That is, without labeling the bins or revealing the 2 categories you have in mind, begin sorting the pictures into the bins. Let the students guess what the labels should be.

Falling Leaves

In autumn when leaves begin to fall, take students on a walk to collect leaves. Back in the classroom, spread the leaves out on a large table. Sort them as many ways as possible, encouraging students to suggest sorting categories. For example, leaves might be sorted according to the following attributes:

- color
- size
- width

Share some of the ways botanists categorize leaves:

- simple (one leaf per stem) or compound (more than one leaflet per stem)
- edges (smooth or saw-toothed)
- shape (no projections, rounded or pointed lobes, needle-shaped, etc.)

Note: If leaves are unavailable, other natural objects such as rocks, seeds, or shells can be sorted.

Problem Solving

Sort and Recycle

Discover the recycling resources in your community. You may need to write a letter or place a call to a waste collection agency or recycling drop-off facility to find out what items can be recycled in your area. Also, find out if your school and lunchroom take part in any recycling efforts. Discuss what your class can do to help recycle and to prevent needless waste. For example, you might use 3 boxes for sorting the scrap paper in your classroom. One box can hold paper that is ready for the recycler. One box can hold old worksheets, etc., whose reverse sides can still be used for notes, sketching, and coloring. The other box can hold scraps of colored paper for art projects. Copy page 64 to make the labels for the boxes.

Social Studies

Attribute Riddles

Have each student cut out pictures of two similar items (for example, two buildings or two pieces of fruit) from old magazines and paste them in the center of a 12- x 18-inch sheet of white paper. Ask students to think of ways the items are similar and ways the items are different. Have students write two attributes the objects have in common at the top of the paper and two attributes that the items do not have in common at the bottom. Conclude the project by letting each student ask the class an "attribute riddle." For example: "Both of my objects are round and taste good, but one is red and one is orange. What are they?" Give the class a chance to guess before showing the pictures of the objects.

Language Arts



Grandmother's Favorite Animals

Copy page 65 and cut the animal categories apart:

Problem Solving



Discard any categories that seem too difficult for your students and put the rest in a box. Post a large number of animal pictures around the room, including animals from each of the categories.

Tell students that a different category of animal, such as “fish” or “animals with 2 legs” or “furry animals,” is written on each of the slips of paper in the box. Draw one of the slips out of the box (for example, “birds”), but don’t show it to the students.

Explain that you are going to imagine that you took your grandmother to the zoo and that she liked only the type of animal written on the slip of paper. Tell the students that it is their job to guess the type of animal. Say, for example, “I took my grandmother to the zoo. She loved the robins and the cardinals, but she didn’t like the rabbits.” Let students try to guess what type of animal your grandmother liked (birds). Explain that they can gather clues if needed by asking questions such as “Did your grandmother like the monarch butterflies?” After the students have correctly guessed that your grandmother liked only the birds, continue playing the game, giving each student a turn at drawing the category. The animal pictures posted in the area will help students to think of animals they might use in their “grandmother stories.”

Food Pyramid

Science

Draw an empty food pyramid on a large paper-covered bulletin board. Label the categories as shown:

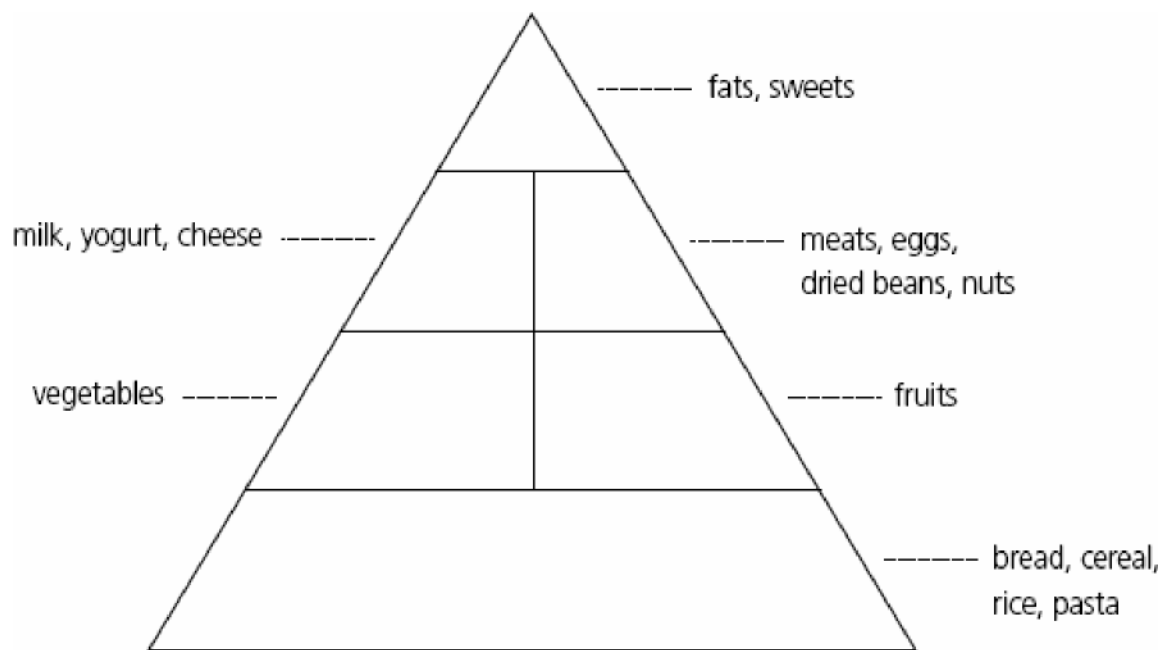

Explain that all foods can be divided into these six groups, and that a healthy diet includes more servings of the foods at the bottom of the pyramid than of those at the top. Have students cut pictures of foods from newspaper grocery ads or magazines. Help them sort the pictures and tack them to the correct places on the food pyramid.

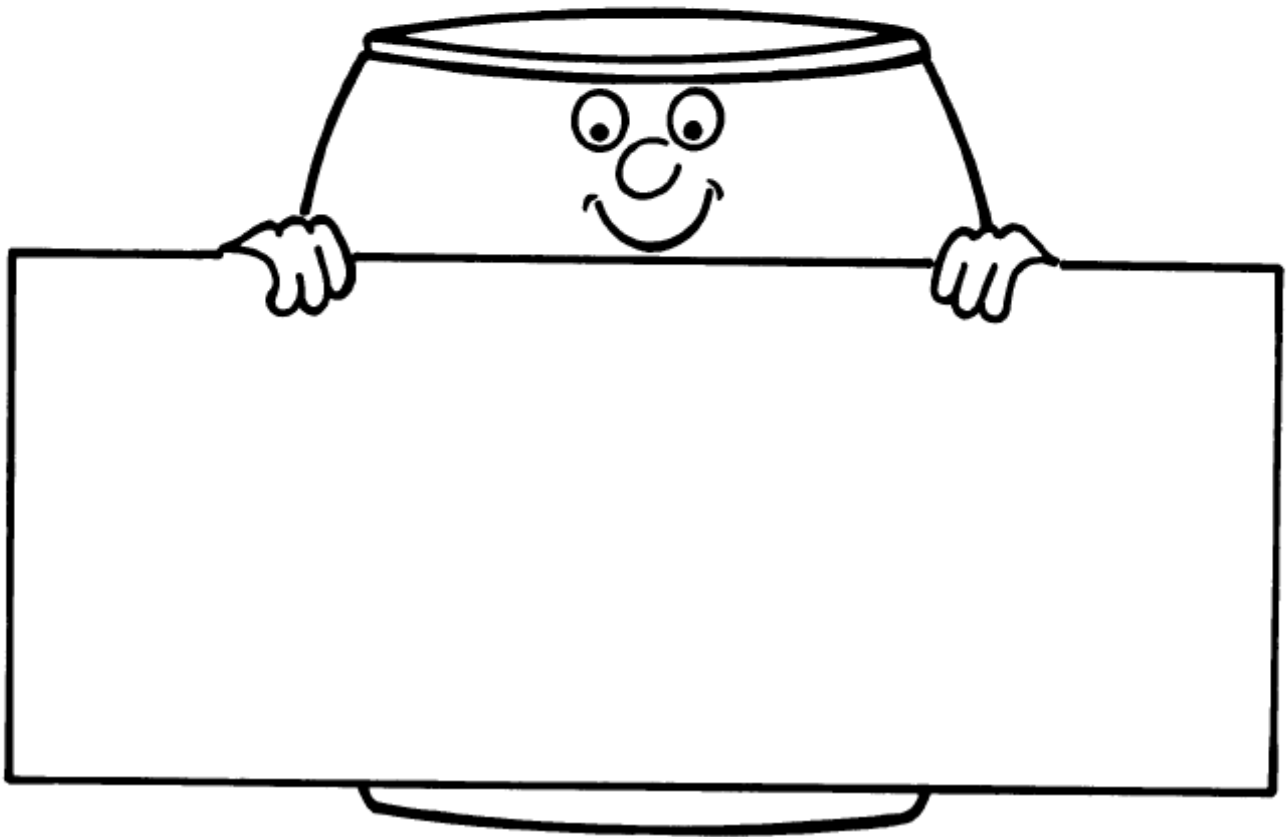
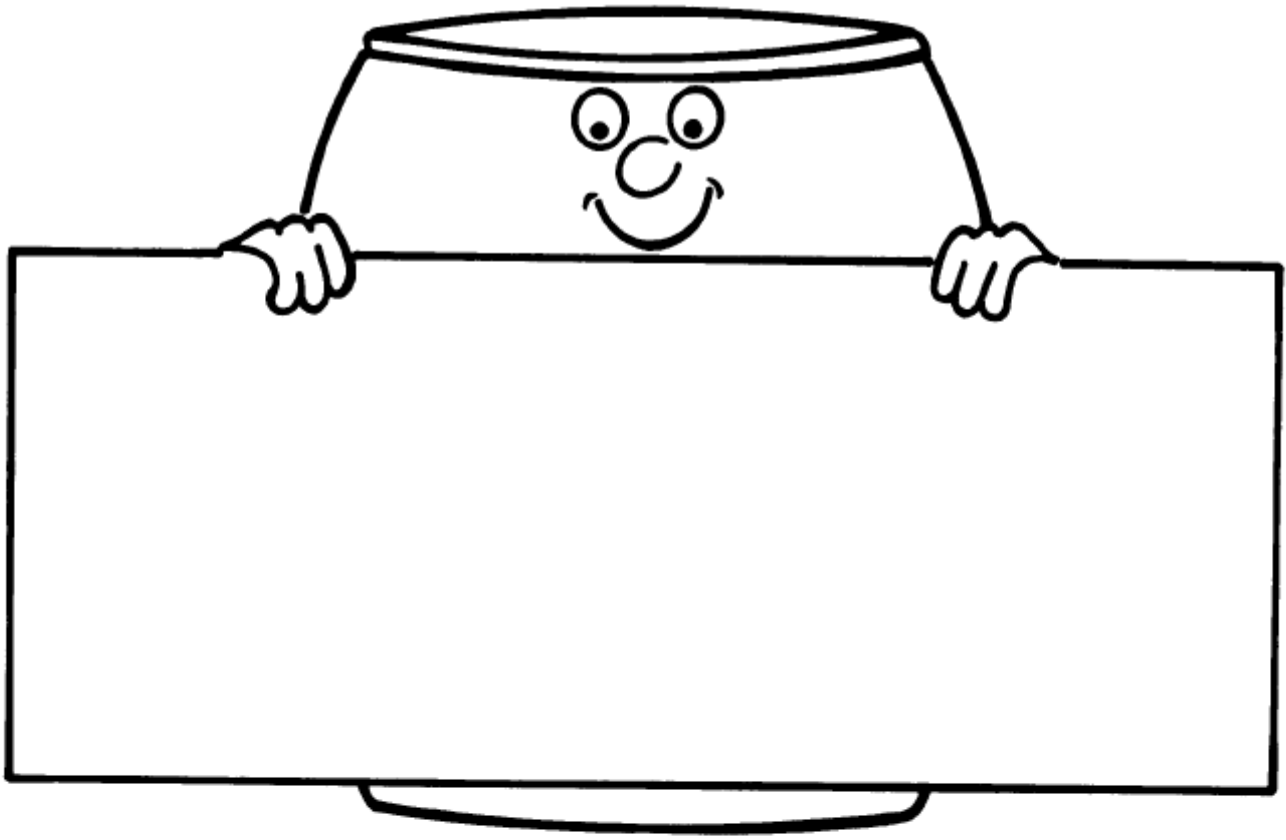

Use with "Bin There" (page 61) and "Sort and Recycle" (page 62).

Grandmother's Favorite Animals

animals with orange on them	birds
animals that climb trees	animals that hibernate
animals with 4 legs	insects
animals with webbed feet	animals with 2 legs
furry animals	animals with scales
animals bigger than a deer	animals with feathers
animals beginning with "R"	animals that fly
animals with antlers or horns	animals without legs
animals that live in water	striped animals
animals with scales	animals kept as pets
animals beginning with "T"	animals with antennae
animals that hatch from eggs	animals beginning with "D"
animals with hooves	brown animals
animals beginning with "S"	reptiles and amphibians
animals smaller than a mouse	animals that migrate
animals beginning with "M"	fish
animals with pinchers	animals with gills

Use with "Grandmother's Favorite Animals" (page 62).

Make-A-Movie



Run the Show

Art

Help students make their own 2-frame movies. They should keep the animation simple, changing only one feature from the first frame to the second. For example:

- a frown changes to a smile
- someone waves a hand back and forth
- a puppy's ear perks up
- someone winks
- a clown blows a bubble
- a balloon pops

The first frame should be drawn on an index card, positioned horizontally. For the second frame, lay a piece of paper on top of the index card and tape it securely on the left end (or on the right end for left-handed students). Use semi-transparent paper (such as thin typing paper) so that most of the first frame can be traced from the index card. Change only the feature that will animate in the movie. To "run the show," roll the paper around a pencil as shown and move the pencil back and forth quickly, rolling and unrolling the paper.

Silent Movies

Creative Dramatics

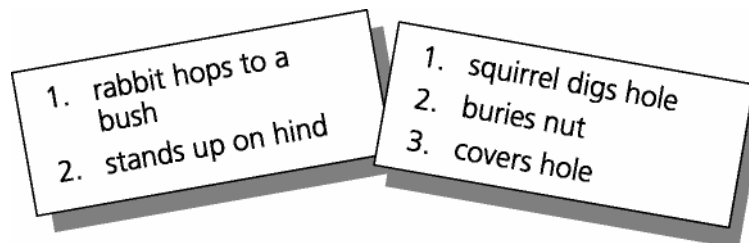
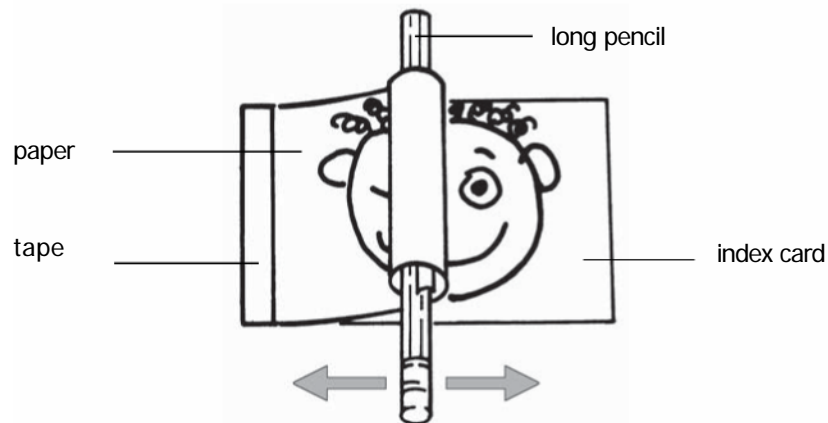

Let a student volunteer draw a sequence (page 70) to pantomime. If needed, help the student read the sequence, whispering so that the other students don't hear. Let the student pantomime the sequence for the rest of the class. Have the class try to guess the 3 steps of the pantomime. Give each student a turn at drawing a slip from the box and pantomiming the sequence on it. All sequences involve plants or animals from the Acorn Pond activity in *Sammy's Science House*.

1-2-3 Books

Language Arts

Let each student pick one of the following topics for a "1-2-3 book":

- 3 stages in the life cycle of a frog
- 3 stages in the life cycle of a salamander
- 3 stages in the life of a robin (egg, young, adult)
- 3 stages in the life of a turtle (egg, young, adult)
- 3 views of the sky as a rainstorm passes through
- an oak or maple tree as it looks in 3 different seasons
- 3 positions of the sun in the sky during the day
- 3 segments of an activity (sunbathing, jumping in pool, drying off)
- 3 things the student does each day

Give each student 3 sheets of paper (about 4 x 6 inches). Have students draw illustrations for their topics at the top of each of the pages. Then suggest that they experiment with putting the 3 illustrations in various logical sequences. There will be more than one possibility (for example, frog-egg-tadpole, egg-tadpole-frog, or tadpole-frog-egg). Staple the pages together in a sequence chosen by the student, adding a construction paper cover, if desired. Have students complete their books by writing brief captions or sentences under the illustrations.

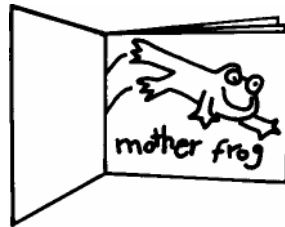

Plant Progress

Science

Let each student plant a few seeds in a paper cup. Use fast-growing seeds such as radish seeds or bean seeds. Each student should plant only one type of seed. Make copies (1 per student) of the current calendar page for students to use as "plant diaries." Have students use words and/or sketches to record when a plant emerges, how the leaves unfold, height on various dates, emergence of new leaves, etc. If accidents happen (plant dries up or gets knocked over), students should document that, too.



At the end of the period, let the students take their plants home. Suggest that they show the growth sequences documented on their calendars to their families.

First Things First

Social Studies

For this activity, either take advantage of a field trip already scheduled or plan a field trip to a nature center, hospital, or other interesting place in your community. After the trip, ask students to list all the things they did on the trip as well as things leading up to the trip. You can include steps such as getting permission slips signed, reading about the topic beforehand, getting on the bus, entering the building, looking at specific things, etc. Write each activity as a caption at the bottom of a 12- x18-inch sheet of drawing paper.

Distribute the captioned papers to the students. (Assign students to work in pairs if there are not enough papers to go around.) Let students use crayons or markers to illustrate their captions. When they are done, work together to sequence the pages in chronological order. If possible, display the work in order around the perimeter of your classroom or down a long hallway. Alternatively, assemble the papers into a classroom booklet that students can use to remember their field trip.

Which Comes Next?

Science

Using copies of pages 71, 72, and 73, set up 6 science experiment stations around your classroom. Each station should include:

- the supplies listed for the experiment
- "Step 1" of the experiment mounted on the left half of a 9- x 12-inch sheet of colored construction paper
- the words "Which Comes Next?" mounted at the top right of the construction paper
- the two small illustrations (cut apart, but not mounted)

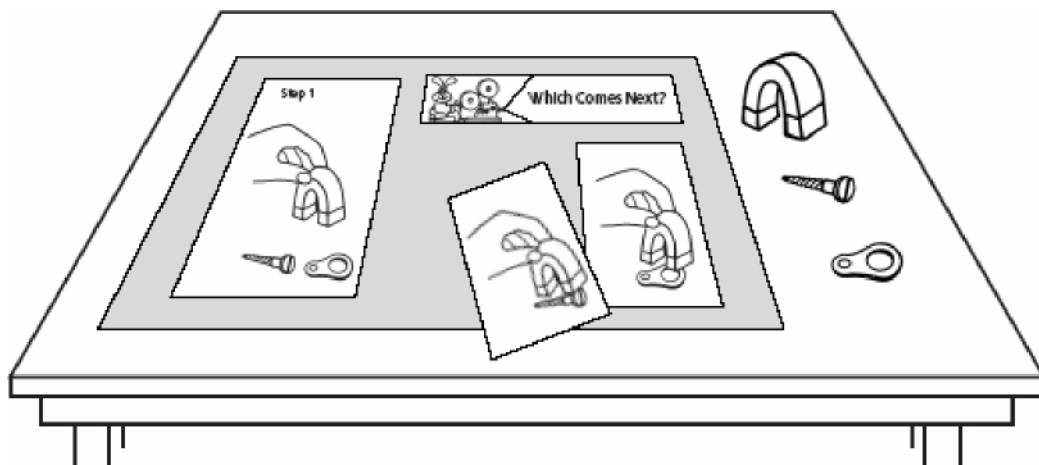

Schedule time throughout the week for students to work in pairs, visiting each station. Instruct student pairs to predict which illustration belongs under “Which Comes Next?” and to put that illustration in place. Only one illustration is correct (is part of the sequence); the other is incorrect (is not part of the sequence). Suggest that discussing previous experiences and observations may help students make the right prediction. Next the students should conduct the experiment to see if their answer is correct. Before leaving the station, they should put everything back where it was so that no clues are left for the next students.

After all students have had a turn at the stations, ask them to explain what happened in each experiment and why they think it happened. Then briefly discuss the scientific principles behind the experiments:

- **Eraser and candle experiment:** The eraser is heavy for its size (dense), so it sinks. The candle is light for its size (not as dense), so it floats.
- **Pencil in water experiment:** Light waves travel faster through air than through water. As the light falls on the water and slows down, it changes direction slightly, “bending” the pencil.
- **Sheet of paper experiment:** When you blow across the top of the paper, you reduce the air’s pushing power (air pressure) on the top side of the paper. This allows the air pressure on the bottom side of the paper to “win the pushing battle” and push the paper up.
- **Magnet experiment:** Only certain metals are attracted to magnets. The screw is iron (attracted) and the flip tab is aluminum (not attracted).
- **Clothespin experiment:** Because the greater weight is on the end with the 2 clothespins, that end must receive the most support to keep the pencil horizontal.
- **Marble experiment:** One by one, the marbles hit each other and pass on the energy. The last marble in the line uses the energy to roll away.

Silent Movies

<ol style="list-style-type: none"> 1. milkweed plant starts to grow 2. grows tall 3. bud opens into a flower 	<ol style="list-style-type: none"> 1. shrew scurries through the grass 2. stops 3. scratches nose with paw 	<ol style="list-style-type: none"> 1. crayfish sits at bottom of pond 2. grabs plant with pinchers 3. eats
<ol style="list-style-type: none"> 1. squirrel digs hole 2. buries nut 3. covers hole 	<ol style="list-style-type: none"> 1. robin turns head to listen 2. grabs worm 3. pulls worm out of ground 	<ol style="list-style-type: none"> 1. butterfly sits on flower 2. flaps its wings 3. flies away
<ol style="list-style-type: none"> 1. snake slithers through grass 2. sniffs for bug (using tongue) 3. eats bug 	<ol style="list-style-type: none"> 1. turtle walks slowly 2. stops 3. pulls legs and head into shell 	<ol style="list-style-type: none"> 1. raccoon asleep in hole in tree 2. wakes up 3. peeks out of hole
<ol style="list-style-type: none"> 1. cardinal sits on log 2. pecks at bug 3. eats bug 	<ol style="list-style-type: none"> 1. robin flies to babies in nest 2. feeds worm to babies 3. flies off 	<ol style="list-style-type: none"> 1. crayfish walks backwards 2. walks sideways 3. walks forward
<ol style="list-style-type: none"> 1. frog watches fly 2. catches fly 3. waits for another fly 	<ol style="list-style-type: none"> 1. oak leaf flutters in the breeze 2. falls through the air 3. lays on the ground 	<ol style="list-style-type: none"> 1. skunk walks slowly 2. stamps foot 3. raises tail
<ol style="list-style-type: none"> 1. rabbit hops to a bush 2. stands up on hind legs 3. nibbles bark 	<ol style="list-style-type: none"> 1. frog hops to pond 2. slips into water 3. swims away (with frog kick) 	<ol style="list-style-type: none"> 1. deer walks along 2. stops 3. bounds away
<ol style="list-style-type: none"> 1. deer walks to pond 2. lowers head to water 3. laps water 	<ol style="list-style-type: none"> 1. caterpillar munches on leaf 2. crawls on 3. munches some more 	<ol style="list-style-type: none"> 1. snake slithers through grass 2. goes up on log 3. suns self
<ol style="list-style-type: none"> 1. raccoon walks to pond 2. scratches in water for food 3. eats food 	<ol style="list-style-type: none"> 1. squirrel runs behind a tree 2. peeks out other side 3. runs some more 	<ol style="list-style-type: none"> 1. squirrel digs in ground 2. takes out nut 3. eats nut
<ol style="list-style-type: none"> 1. butterfly breaks out of chrysalis 2. flaps wings to dry 3. flies away 	<ol style="list-style-type: none"> 1. baby turtle cracks open its eggshell 2. walks to pond 3. slips into pond 	<ol style="list-style-type: none"> 1. salamander digs under leaves and dirt 2. curls up 3. hibernates
<ol style="list-style-type: none"> 1. muskrat walks with stick in mouth 2. lays stick on roof of lodge 3. pats it into place 	<ol style="list-style-type: none"> 1. fish swims toward some frog eggs 2. eats frog egg 3. swims away 	<ol style="list-style-type: none"> 1. baby robin hops up on edge of nest 2. flaps wings 3. hops back down

Use with "Silent Movies" (page 66).

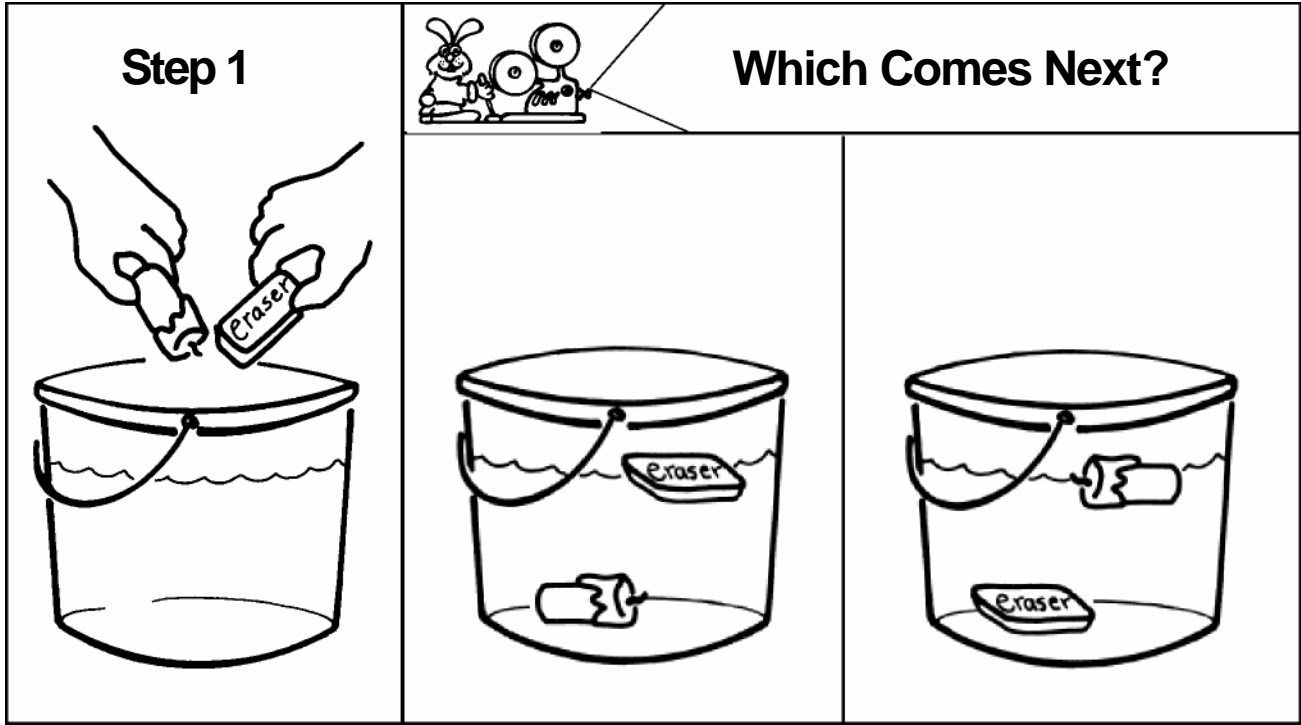

Supplies: candle, eraser, bucket of water

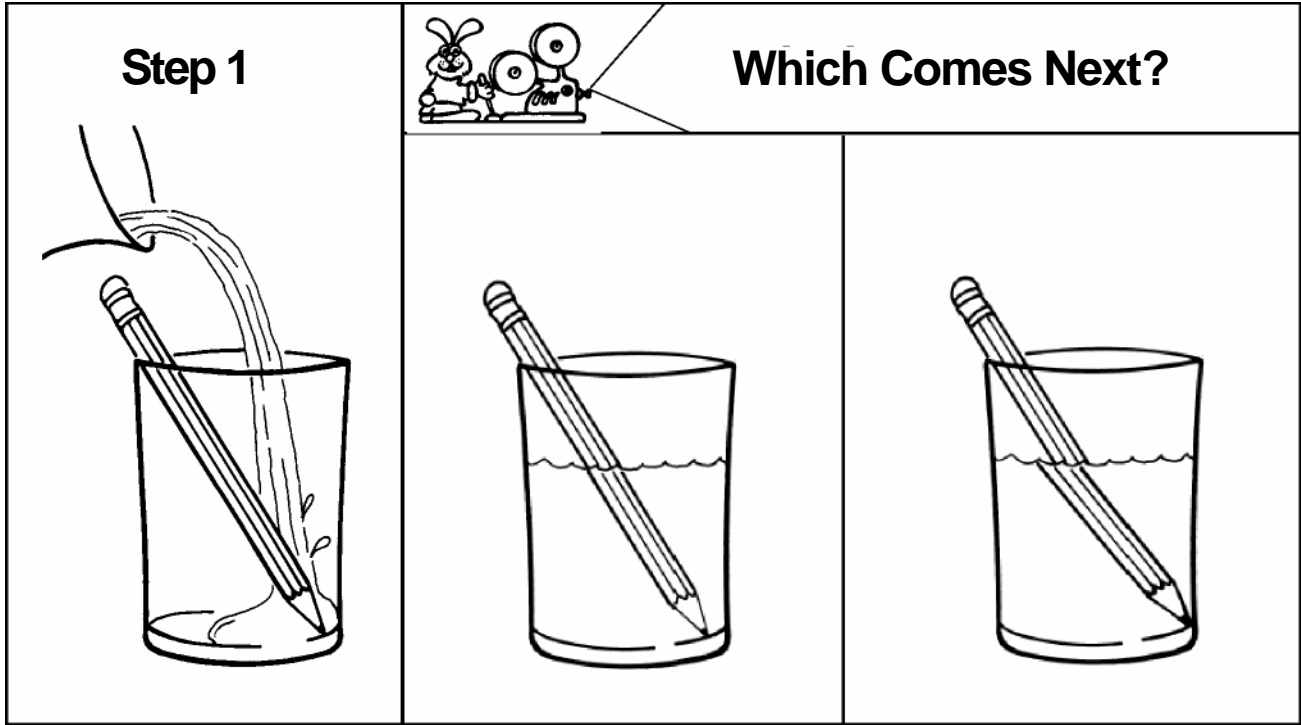

Supplies: pencil, transparent drinking glass, pitcher of water

Use with "Which Comes Next?" (page 68).

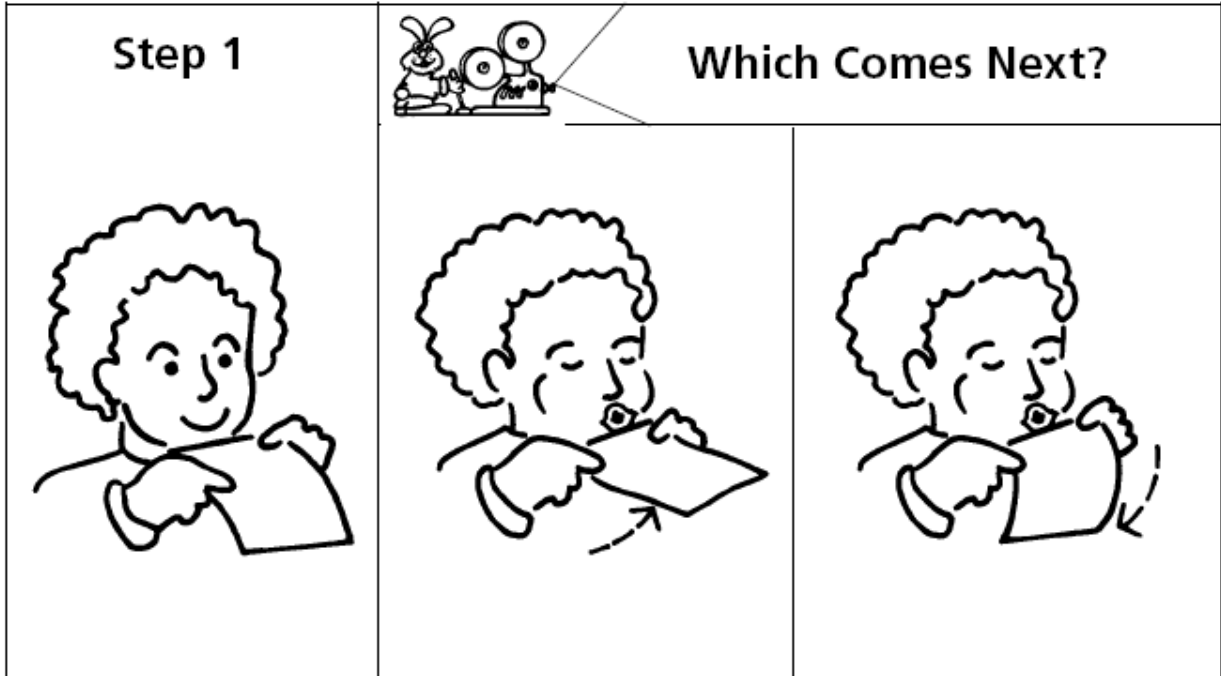

Supplies: thin sheet of paper (about 6- x 9-inch)

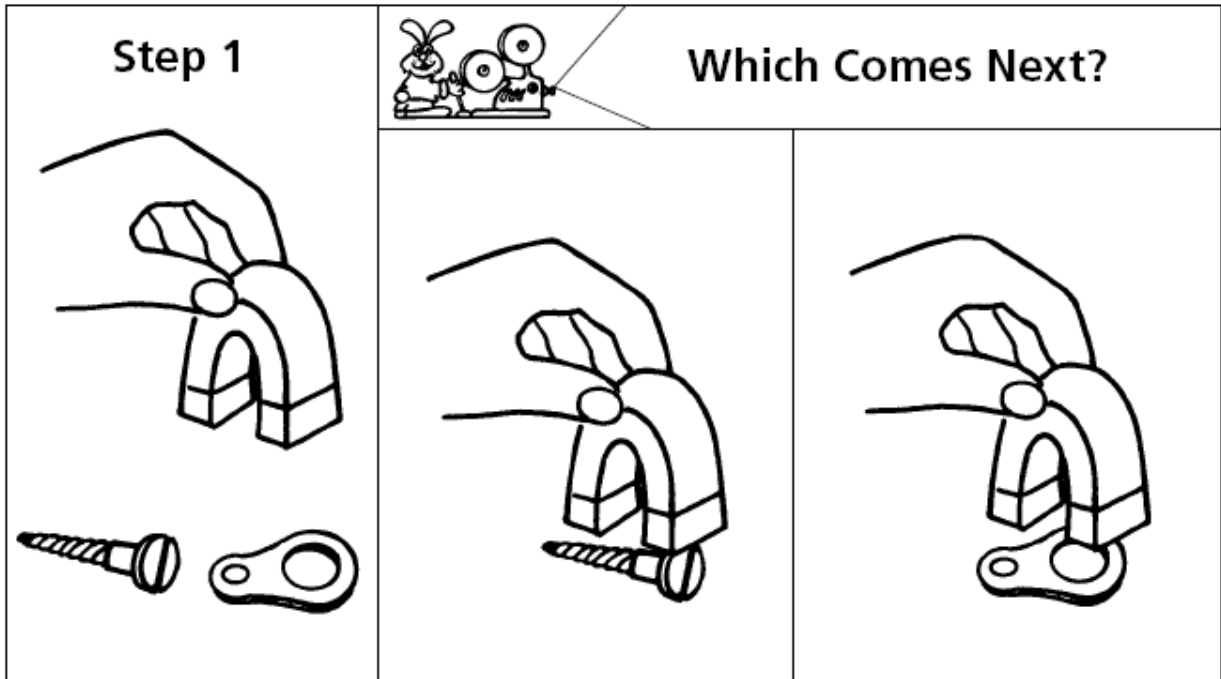

Supplies: magnet, aluminum can flip tab, steel screw

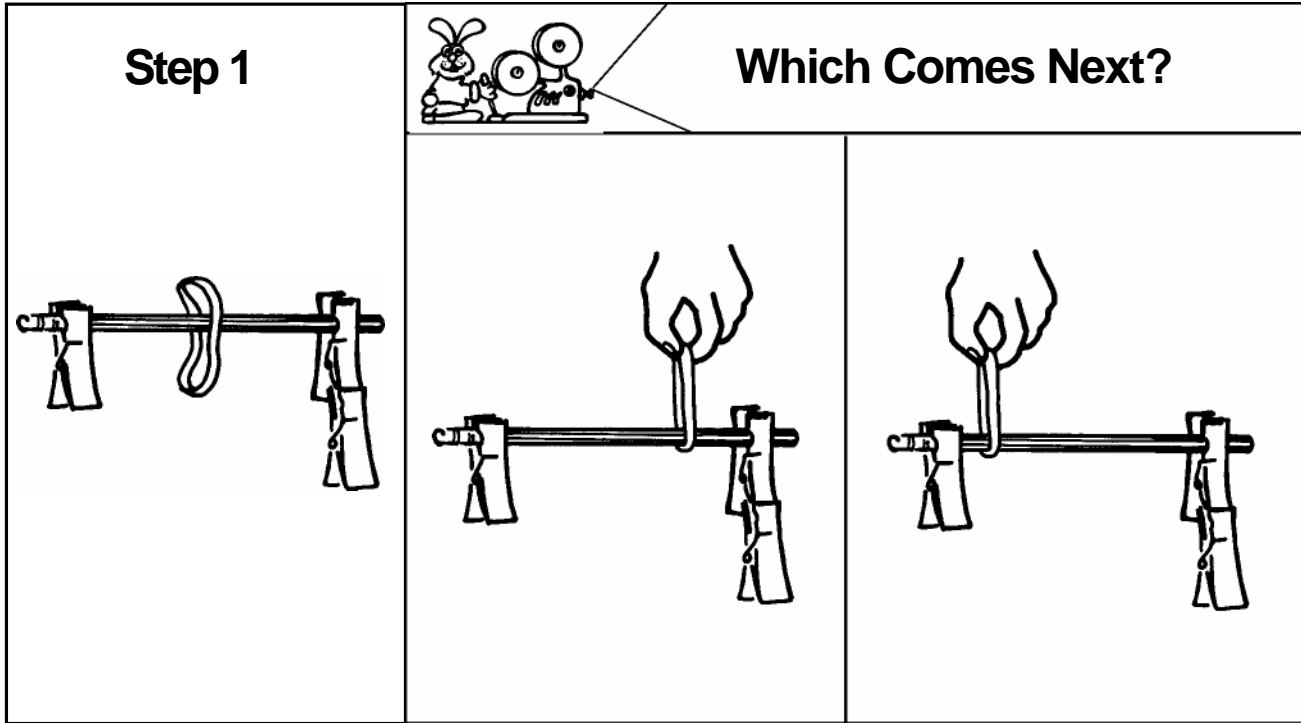

Supplies: unsharpened pencil, 3 spring-type clothespins, wide rubber band (allow students to assemble apparatus).

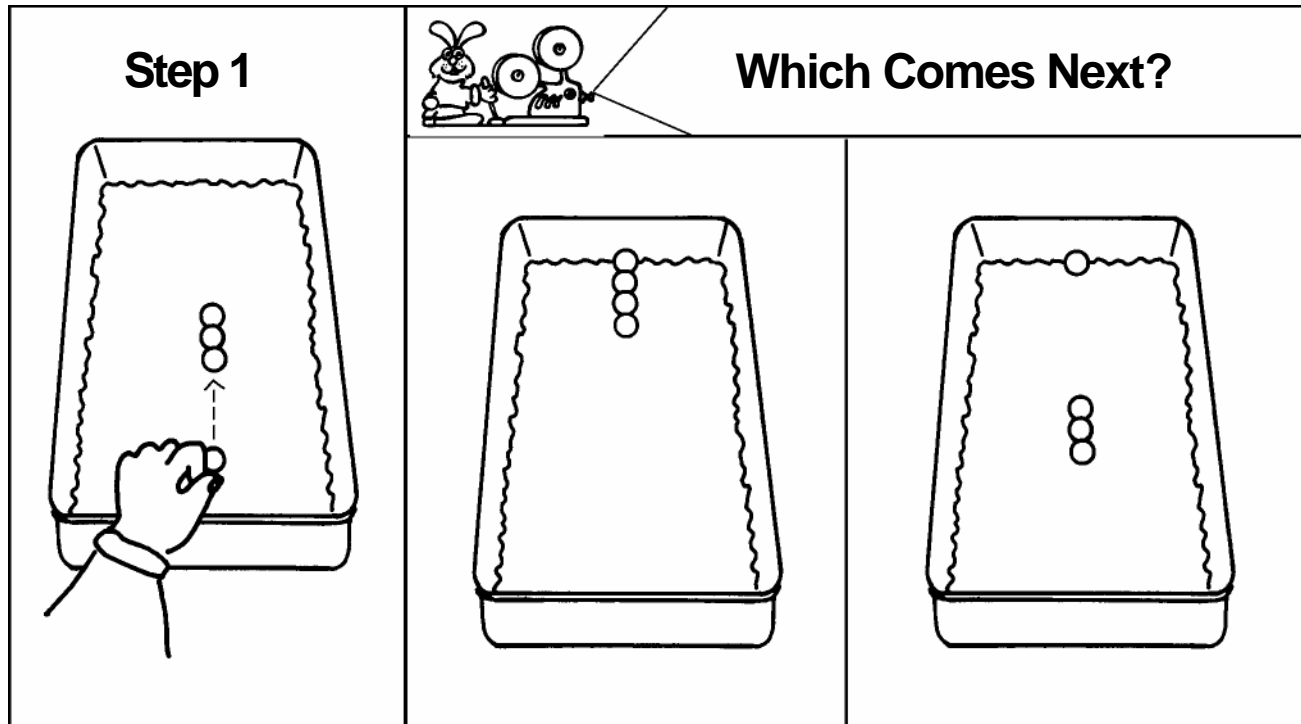

Supplies: 4 marbles (allow students to arrange), cake pan lined with terry cloth hand towel.

Use with "Which Comes Next?" (page 68).

Acorn Pond

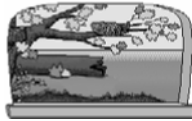

Bouncing Butterflies

Art

Bring a variety of butterfly books into the classroom. Read some together and provide time for students to browse through any butterfly identification books you may have gathered. Provide crayons and give each student a copy of page 78.

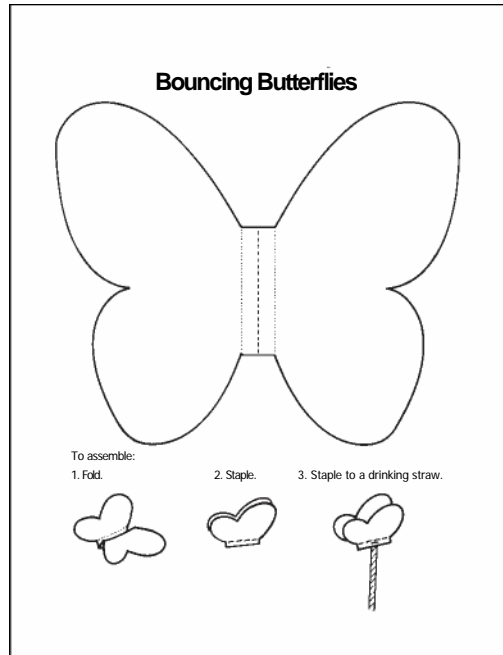

The butterfly on the page can be colored realistically, using the information from the butterfly books, or it can be colored with imaginative designs. Suggest that students press hard with the crayons to produce the intense colors that butterflies have. The section between the dotted lines need not be colored. When the top sides are finished, have students cut out their butterflies and color the undersides completely. (Because some crayon may rub off onto the work surface, students should work on a sheet of scrap paper or on a protected table.)

Assemble the butterflies as illustrated on page 78. To make a butterfly flap its wings, hold the straw and move it up and down.



Nature's Colors

Art

Set up four work tables, one table for each season of the year. Set out paints of appropriate colors for the seasons, paper, and brushes. If you are unsure about the colors, look at the colors of the various seasons in the Acorn Pond activity of *Sammy's Science House* or follow these suggestions:

- Spring clear (not muted) light colors, yellow greens, aqua, yellow, tan, lavender
- Summer medium colors, true greens, sky blue, red, rose
- Autumn rich earth colors, olive, rust, gold, orange, brown
- Winter pale gray, pale blues, white, a few vivid colors, black, black-brown

Discuss the idea that each season has its own palette. Show the four tables to the students. Ask them to guess which table is for autumn. Next, try winter and then summer and spring. Allow time for each student to use the palette of one of the seasons to paint a nature scene. If there is time, students may enjoy making additional paintings of their scenes as they would look in different seasons.

Under a Log

Science

After students have had a chance to play with the Acorn Pond activity in *Sammy's Science House*, discuss the fact that certain animals depend upon a pond environment for their existence. Ask, for example, how crayfish or frogs depend upon their environment throughout their life cycles and in various seasons. Explain that there are communities of animals everywhere that are well suited for their particular environments.

You can probably discover one of these communities near your school. Look for a fallen log or branch on the playground or nearby. Help students to turn it over, to examine what they find, and then to replace the log carefully. If your students made bucket magnifiers (Buzzy Bee's Bucket Magnifier, pages 48 and 51), this is a good opportunity to use them. Magnifying glasses can also be used. Illustrated below are some of the animals your students might find:



Sow bugs or woodlice are related to lobsters.



Don't touch! A centipede bite stings.



Ants tunnel and lay eggs in dead wood.



Slugs are like snails without shells.



The mother wolf spider carries her babies on her back.



Earthworms eat dead plant material in the soil.

Let students look for other small communities under rocks and fallen leaves or even in a ring of grass. Stress the idea that it is important to examine carefully, disturbing as little as possible and returning the area to its original state after looking for these communities.

Sammy's Field Notebook

Language Arts

The Field Notebook in the Acorn Pond activity of *Sammy's Science House* can be printed by clicking the printer icon. (See page 30.) Some suggestions for using printouts of the Field Notebook follow:

- **Field Notebook Posters:** Let students color the pages of the Field Notebook as posters. Mount them on colored construction paper (one animal per poster) and hang them at eye level for students to view at their leisure.
- **Animal of the Week:** Prepare Field Notebook posters as above, but display only one at a time, as the Animal of the Week. Each week, change the poster and read the new one together.
- **Field Notebooks for Everyone:** Use a copy machine to make a copy of the Field Notebook for each student. Assemble the notebooks by stapling the pages together at the top or on the left, adding a construction paper cover, if desired. Provide time for students to browse through them and to color or highlight items as they wish. Read the booklets together if students are unable to read them on their own.
- **Field Notebooks with Added Notes:** Assemble Field Notebooks as in the previous paragraph, but add some blank pages. Let students use the blank pages for observations about pets or other animals they see regularly. Suggest that they carefully study animal behavior the way scientists do. For example, what does it mean when your dog puts up its ears? How large is your cat's territory? How many claws are on your guinea pig's foot?
- **Field Notebooks from Other Environments:** Using a Field Notebook as a model, work as a class to make a similar notebook about animals in a different environment, such as the rain forest. Have each student or pair of students contribute one page of interesting "field notes" about a rain forest animal.

Jump Like a Frog

Physical Education

Next physical education class, warm up with the animals of Acorn Pond by asking students to do several of the following:

- Jump like a frog.
- "Fly" like a butterfly.
- Walk like a crayfish (backwards, sideways, forward).
- Slither like a snake.
- Flap your "wings" like a baby robin.
- Hop like a rabbit.
- Dig like a squirrel.
- Walk like a turtle.
- Run like a deer.

After the class has tried the activities for the similes listed, let students create their own.

Visit a Pond

Science

Explain that Acorn Pond in *Sammy's Science House* was modeled after an actual pond in the midwestern United States and includes plants and animals that really exist at that location. If possible, plan a field trip to a pond in your area. Before you go, talk about our responsibility to take good care of the wonders of nature. Make copies of page 79 so that each child can have a pocket-sized naturalist card. Your class can write its own motto (see bottom of page 79) or use Olivia Owl's motto (see top of page 79).

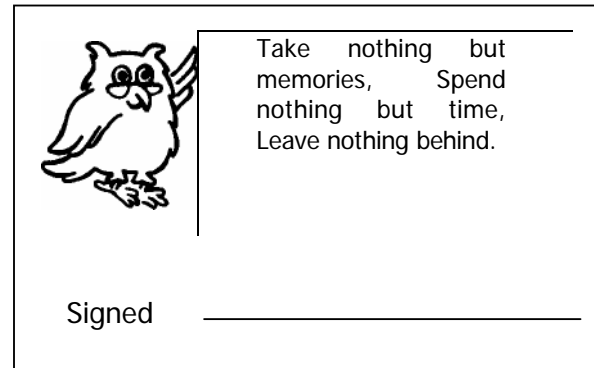
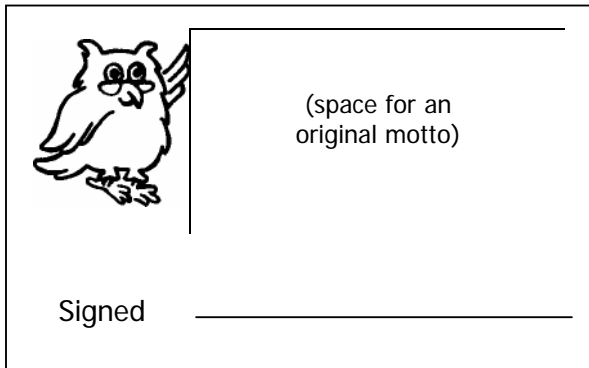

If your students have made field notebooks with extra pages, take them along. Have students use them to record observations and make sketches. If possible, arrange for a naturalist or the owner of the pond to talk to the class about the pond and its plants and animals. Back in the classroom, compare the pond you visited with Acorn Pond.

If it is not possible to take a field trip to a local pond, you can still "visit" a pond through books. There are many good books about ponds available for young students. Below are a few your students might enjoy:

Puddles and Ponds, by Phyllis S. Busch

At the Edge of the Pond, by Jennifer Owings Dewey

The Birth of a Pond, by John Hamberger

A Walk by the Pond, by Wallace Kirkland

Lily Pad Pond, by Bianca Lavies

At the Frog Pond, by Tilde Michels

Discovering Pond Life, by Colin S. Milkins

Pond and River, by Steve Parker

The Hidden Life of the Pond, by David M. Schwartz

Bouncing Butterflies

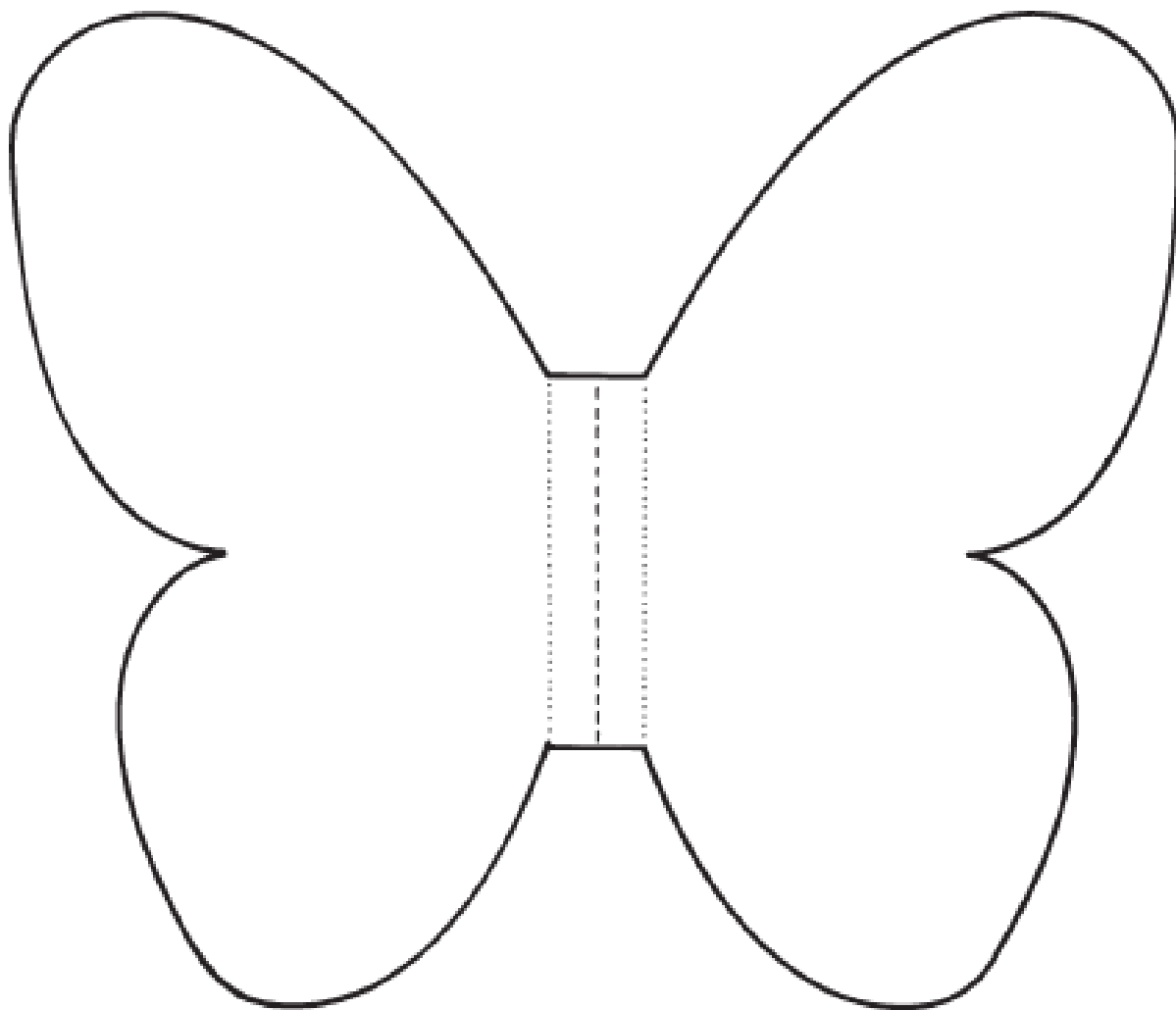

To assemble:

1. Fold.

2. Staple.

3. Staple to a drinking straw.



Use with "Bouncing Butterflies" (page 74).

Naturalist Cards

Using heavy paper, copy Olivia Owl's naturalist cards for your students. Read and discuss the motto together. Then let each student sign and cut out a card. If possible, laminate the cards or cover them with clear adhesive-backed paper.



Take nothing but memories, Spend nothing but time, Leave nothing behind.

Signed _____



Take nothing but memories, Spend nothing but time, Leave nothing behind.

Signed _____



Take nothing but memories, Spend nothing but time, Leave nothing behind.

Signed _____



Take nothing but memories, Spend nothing but time, Leave nothing behind.

Signed _____

If your class prefers to make up its own motto, use this card instead. Print the class' motto in the rectangle before copying the card for your students.



Signed _____

Create-A-Critter



Jumbled Jungle

Art

First, get enough sheets of plain paper—8-1/2 by 11 inches—to supply your whole class. Fold each paper in thirds, as you would fold it to insert it into a legal-size envelope. Then divide the class into groups of three, giving each child a folded piece of paper and crayons or colored pencils. Each child should draw the top of an animal on the top third of their piece of paper. Then they all pass their papers to the right, and everyone draws the middle of the animal on the middle of the paper. (You might ring a bell when it is time for everyone to trade papers.) For the final turn, pass the papers to the right again and everyone draws the bottom of the animal on the bottom third of the paper. No fair peeking until the whole thing is done! When everyone finally unfolds their papers, they will see funny animals. Give each animal a name and show it to everyone in the class.

Fur, Feathers, or Scale

Math

Make enough copies of the worksheet on page 82 for your entire class. Review with your class the fact that all animals are covered with fur, feathers, scales, or smooth skin. Give some examples in your discussion, and talk about why animals need different types of covering. Then pass out the worksheet and explain that there is one animal in each row that has a different covering than the others in the group. Students should find and circle the different animal.

As a follow-up, go over the worksheet with the students, having them name the animals and their skin coverings. Create a graph on the chalkboard, whiteboard, or large chart paper. Name the graph "Skin Coverings." Label the y-axis (vertical line) "number." Along the x-axis (horizontal line) list the four different skin coverings. Have students come up and add animals to the graph in the proper places. Think of adding some animals that are not on the worksheet, but that fit the categories.

What Animal Am I?

Creative Dramatics

Divide the class into two teams to plan animal charades. Each team decides on an animal that they want to portray. They come up with several clues about the animal, such as where it lives, what sound it makes, what its body covering is, how it moves, etc. (You may need to assist teams in writing down their suggested clues.) Then each team tries to guess the other team's animal. Students take turns giving clues, including showing how the animal moves and how it sounds. If you want to keep score, time the game. The team that gets the correct answer first wins! After one round, have each team choose a new animal and begin again.

Pet Parade

Language Arts

Have a day when students can bring in a magazine picture of a pet. This could be similar to a pet that the child has or would like to have. Let each child tell a little about their “picture pet,” what its name is, and how he or she would play with it. Tell how the pet moves, how it sounds, and what its body covering is. Talk about the responsibility that we have to care for our animals, and have children tell how they help with that responsibility at home. How are tame pets different from animals in the wild? Why are some animals not suitable as pets?

You may wish to mount the pictures on recycled cardboard or art paper. The students can write the name of the animal with the picture. On the back, students who are more comfortable with writing can add short descriptions of some characteristics of the animal: where it lives, what it eats, how it acts.

You can stress verbal communication and written word-spoken word connections with a small soft ball. Start the activity by tossing the ball to a student. The student reads the name of his or her animal and tells something about it. When finished, he or she tosses the ball to another student. The activity continues until all students have had a least one turn. (Be sure that the ball is extremely soft and the students have seen the proper way to toss it.)

Critter Masks

Art

In this activity, students will create paper plate critter masks for an animal play. Provide three work stations so students can make their choice of animals.

Station 1: Fur—provide felt, yarn, or faux fur.

Station 2: Feathers—provide feathers of different colors and sizes.

Station 3: Scales—provide sequined trim, individual sequins, or textured fabrics.

Each station should provide paper plates, yarn, colored markers, glue sticks, etc. The first step is to cut eye holes in the paper plates. Students then decorate the plates to create their fantastic animal masks. When they are finished, they can glue long sticks (like popsicle sticks) to the masks so they can hold them up in front of their faces. Divide students into groups of three or four and have them do a short skit for their classmates featuring their fantastic critters. Be sure to show how the animals move and sound!

Fur, Feathers, Scales, or Skin?



Use with "Fur, Feathers, or Scale" (page 80).

Recycle It!



What's Gone!

Social Studies

Help the students set up a classroom recycling system. They should decide what kinds of materials should be provided a designated container (aluminum, paper, plastic.) You may wish to have a general container for “trash,” items that may or may not be recyclable but surely should not be handled above normal disposal by the students (used writing materials, art materials, etc.). Set up a buddy system for putting things into recycling that keeps everyone safe and records the number and types of materials in a given container. If a scale is available, weigh each container at the end of the week and record the amounts on a graph or chart. Discuss ways to reduce or reuse the materials in the recycling system and discover if the class can lower the amount of recycled materials over time. Invite the principal or other classes to a presentation of the results.

Recycle a Song!

Music

Pick a favorite song and sing it as a class. Ask students how they think you can “recycle” the tune. Write a few of the words on the board and invite students to make up new words—taking an old tune and making it new again. The songs can be written on chart paper and posted around the room or the school. After learning the songs, the students could share them with other classes, the principal, or their parents.

Reuzanimals

Art/Science

Have each student select one piece of material that could be recycled, or bring from home old buttons, jewelry, fabric scraps, or other items. This material should be used as the basis for the creation of a new kind of animal, the Reuzanimal. Attached to a piece of flattened cardboard box (art paper or board) the material might form the body, head or appendage(s) of a new kind of animal. Using markers or other writing materials, the students finish the picture of the animal and name it. Create a display in the classroom or around the school. You might want to have the students describe the activities of the Reuzanimals and how they help the environment.

Cleaning the Environment

Mathematics

Take four large manila envelopes and label them Glass, Paper, Aluminum, and Plastic. Paste a recycle symbol (page 85) on each envelope. Have students cut out magazine pictures of recyclable items—glass, paper, aluminum, and plastic. (Alternately, they could draw pictures of these items.) Then, when the class is out of the room, scatter the pictures of recyclable materials all over the classroom. The students will be surprised when they return! Explain that they need to help clean up the classroom by picking up all the recyclables and putting them in the proper envelopes. You may wish to remind the students of safety by preparing special tools for picking up the materials. Call attention to the recycle symbols on the envelopes. When all the trash is picked up, go through the contents of each envelope with the students to see if everything was sorted properly. Discuss with the class how recycling, and using recycled materials, helps our environment.

After verifying correct sorting, have students count the pieces in each envelope. Record the tally on the blackboard: 10 pieces of glass, 6 aluminum cans, etc. Hand out copies of the graph on page 86 and have each student make and label a graph representing the breakdown of the recyclable materials.

Reword!

Language Arts

Select as many familiar words as you can. Use words such as bat, cat, rat, pick, pack, back, win, fin, pin, fall, wall, ball, tall, tack, sack, and sick, that have similar beginnings and/or endings. Place the words on cards (page 87) that can be cut. Hold up the words one at a time and have the students read them. Then, announce that the words have all been used and might as well be thrown away. Cut them at the appropriate place between the first letter and ending rime (between “b” and “all” in ball, for example) and drop them all into a box or bag. Pass the word pieces around and have the students build the pieces back into words.

Recycling Symbols



Recycling Graph

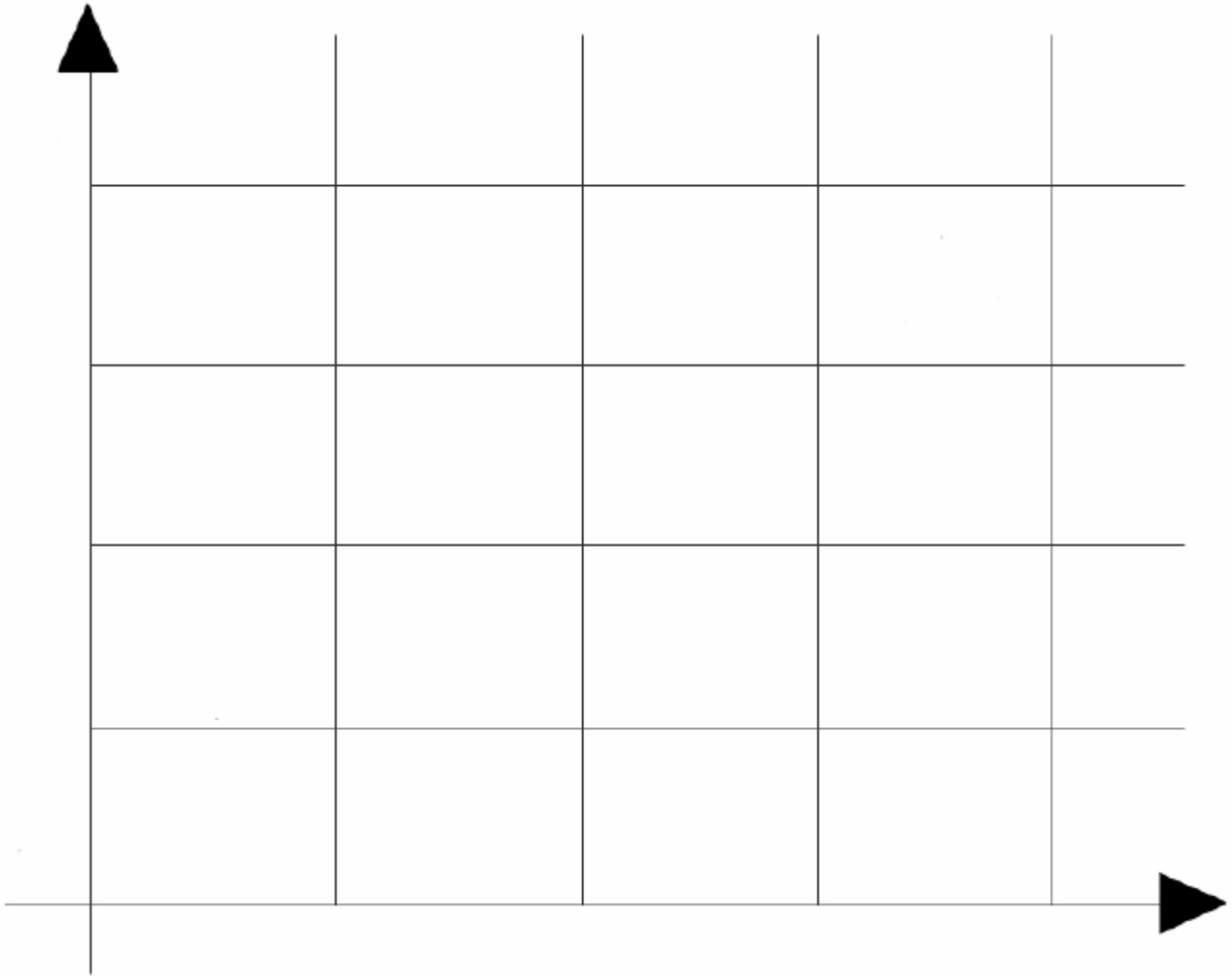

Use with "Cleaning the Environment" (page 84).

Reword! Cards

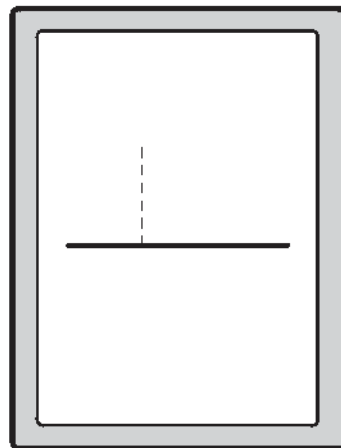
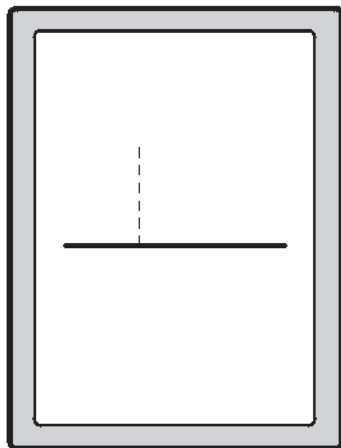
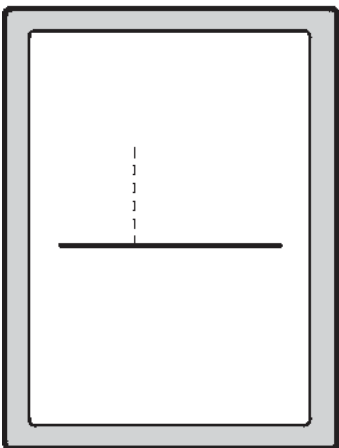
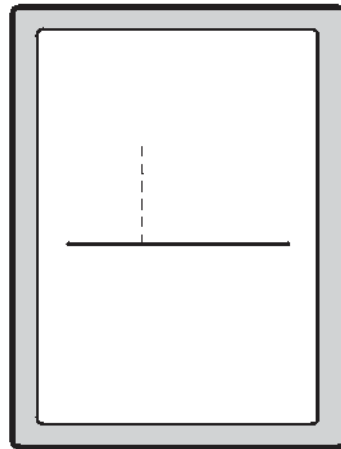
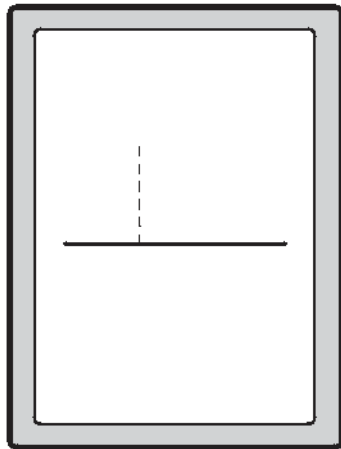
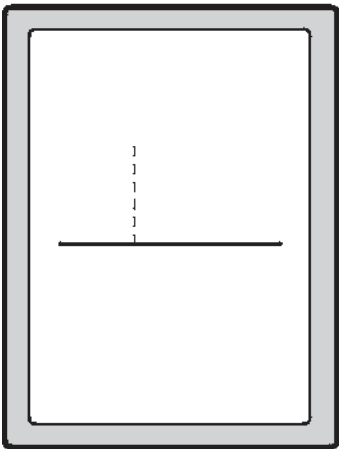
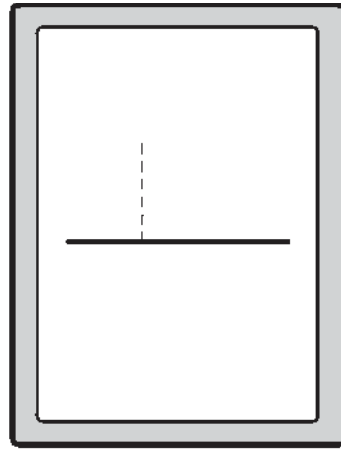
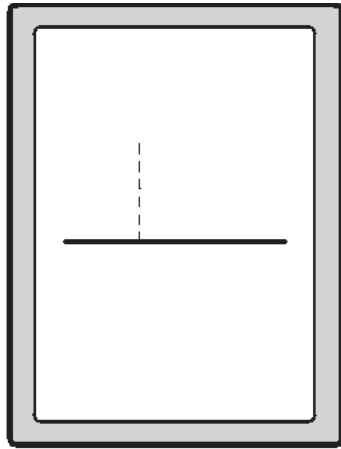
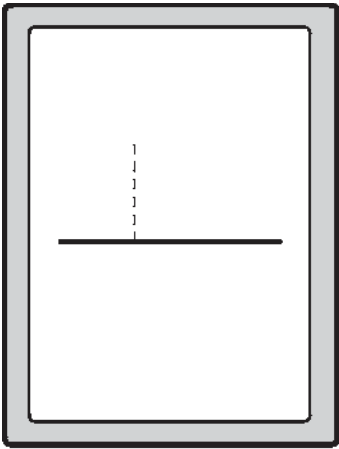

Use with "Reword!" (page 84).

Notes...

System Requirements

Windows®

- Operating System: Windows 98 SE, Windows 2000, XP Home, XP Professional (with latest Service Packs)
- CPU: Pentium III 733 Mhz or better
- Hard Drive: 100 MB free
- RAM: Minimum 128 MB
- Graphic Card: 800 x 600 Hi Color 16-bit (thousands of colors) or higher
- Network Card: 10Base-T or better
- Sound Card: SoundBlaster 16 or compatible (Headphones recommended)

Optional

- Printer
- Touch Window

Macintosh®

- Operating System: OSX 10.2, 10.3, 10.4, or higher
- CPU: iMAC PPC 750-400 MHz or PowerMac G4-350-Mhz
- Hard Drive: 100 MB free
- RAM: 128 MB
- Graphic Card: 800 x 600 Hi Color 16-bit (thousands of colors)
- Network Card: 10Base-T or better
- Sound Card: Standard Macintosh Sound (Headphones recommended)



**Distributed in Canada by
IBM K12 Education
1-800-66LEARN**

<http://www.ibm.com/industries/ca/en/education/k12/>



www.hmco.com